

## About this Manual

We've added this manual to the Agilent website in an effort to help you support your product. This manual is the best copy we could find; it may be incomplete or contain dated information. If we find a more recent copy in the future, we will add it to the Agilent website.

## Support for Your Product

Agilent no longer sells or supports this product. Our service centers may be able to perform calibration if no repair parts are needed, but no other support from Agilent is available. You will find any other available product information on the Agilent Test & Measurement website, [www.tm.agilent.com](http://www.tm.agilent.com).

## HP References in this Manual

This manual may contain references to HP or Hewlett-Packard. Please note that Hewlett-Packard's former test and measurement, semiconductor products and chemical analysis businesses are now part of Agilent Technologies. We have made no changes to this manual copy. In other documentation, to reduce potential confusion, the only change to product numbers and names has been in the company name prefix: where a product number/name was HP XXXX the current name/number is now Agilent XXXX. For example, model number HP8648A is now model number Agilent 8648A.

# Reference Guide

## Electronic Calibration Modules

**HP 85091A   HP 85092A   HP 85093A**  
**HP 85096A   HP 85098A   HP 85099A**  
**HP 85060B   HP 85062B   HP 85064B**



**HP Part Number: 85091-90008**

Supersedes 85091-90002

**Printed in USA**

**July 1999**

---

## **Notice**

The information contained in this document is subject to change without notice.

Hewlett-Packard makes no warranty of any kind with regard to this material, including, but not limited to, the implied warranties of merchantability and fitness for a particular purpose. Hewlett-Packard shall not be liable for errors contained herein or for incidental or consequential damages in connection with the furnishing, performance, or use of this material.

Hewlett-Packard assumes no responsibility for the use or reliability of its software on equipment that is not furnished by Hewlett-Packard.

This document contains proprietary information which is protected by copyright. All rights are reserved. No part of this document may be photocopied, reproduced, or translated to another language without prior written consent of Hewlett-Packard Company.

---

## **Restricted Rights Legend**

Use, duplication, or disclosure by the U.S. Government is subject to restrictions as set forth in subparagraph (c)(1)(ii) of the Rights in Technical Data and Computer Software clause at DFARS 252.227-7013 for DOD agencies, and subparagraphs (c)(1) and (c)(2) of the Commercial Computer Software Restricted Rights clause at FAR 52.227-19 for other agencies.

---

# Contents

## 1. General Information

Manual Overview . . . . .	1-2
Prerequisite Knowledge . . . . .	1-2
Compatible Vector Network Analyzers . . . . .	1-3
Incoming Inspection . . . . .	1-4
Equipment Recommended but Not Supplied. . . . .	1-4
HP 8509X Series Module ECal Kit Contents . . . . .	1-5
HP 8509X Series Options Available. . . . .	1-5
HP 8506X Series Module ECal Kit Contents . . . . .	1-6
HP 8506X Series Options Available. . . . .	1-6
Serial Numbers. . . . .	1-7
Shipping Instructions. . . . .	1-8
Service and Support. . . . .	1-9
Safety and Regulatory Information. . . . .	1-11
Instrument Markings . . . . .	1-12
Compliance Notices . . . . .	1-12

## 2. Specifications and Characteristics

Specifications: Terminology and Definitions. . . . .	2-2
Environmental Specifications . . . . .	2-3
Operating Temperature and Accuracy Enhancement . . . . .	2-4
Barometric Pressure and Relative Humidity . . . . .	2-4
Mechanical Characteristics . . . . .	2-5
Center Conductor Pin Depth . . . . .	2-5
Pin Depth. . . . .	2-5
Electrical Performance . . . . .	2-6
Type-N 50 $\Omega$ and Type-N 75 $\Omega$ Connector Characteristics . . . . .	2-6
Connector Pin Depth Information. . . . .	2-8
Characteristics and Specifications . . . . .	2-10
Measurement Port Characteristics . . . . .	2-10
Supplemental Characteristics . . . . .	2-14
Electrical Characteristics . . . . .	2-14
Mechanical Characteristics . . . . .	2-15
HP 8509X RF ECal Kit. . . . .	2-15
HP 8506X Microwave ECal Kit . . . . .	2-15
Torque Wrench Information . . . . .	2-16
HP 8509X RF ECal . . . . .	2-16
HP 8506X Microwave ECal . . . . .	2-16
Warranty. . . . .	2-17
Certification. . . . .	2-17
Warranty . . . . .	2-17
Assistance . . . . .	2-18

## 3. Gauging and Making Connections

Handling and Storage . . . . .	3-2
Electrostatic Discharge (ESD). . . . .	3-3
Preventive Maintenance . . . . .	3-5
Visual Inspection . . . . .	3-6

---

# Contents

Look for Obvious Defects and Damage First .....	3-6
Inspecting the Mating Plane Surfaces .....	3-6
Inspecting Slotless Connectors .....	3-7
Checking for Connector Wear .....	3-7
Cleaning Connectors .....	3-8
Checking for Alcohol Contamination .....	3-8
General Cleaning Procedures .....	3-9
Using Compressed Air or Nitrogen .....	3-9
Cleaning the Connector Threads .....	3-9
Cleaning the Mating Plane and Interior Surfaces .....	3-9
Precision 7 mm Connector Cleaning Procedure .....	3-11
Cleaning the Center Collet While It Is in Place .....	3-11
Cleaning a Removed Center Collet .....	3-11
Gauging Devices .....	3-12
Gauge Accuracy .....	3-12
When to Gauge Connectors .....	3-12
Using Connector Gauges .....	3-14
Recognizing Gauge Types .....	3-14
Making Connections .....	3-18
Using a Torque Wrench .....	3-18
Zeroing Connector Gauges .....	3-20
Zeroing the Gauge .....	3-20
Gauging Techniques .....	3-22
Using Male (Screw-on) Type Gauges .....	3-22
Using Female (Screw-on) Type Gauges .....	3-22
Reading the Gauge .....	3-23
7 mm Gauge .....	3-23
Type-N Gauge .....	3-24
3.5 mm Gauge .....	3-25
Type-F Compatibility .....	3-27
Making Type-F Connections .....	3-29
How to Make a Connection .....	3-29
How to Separate a Connection .....	3-31

## 4. Replaceable Parts

---

# **1** **General Information**

## Manual Overview

This manual provides instructions for using the HP 8509X and HP 8506X families of electronic calibration modules, with the HP 85097A PC interface kit. For information about the HP 85060C control unit, refer to the Appendix section of the *Electronic Calibration System User's Guide* (HP part number 85091-90007).

ECal kits are available with modules having the following connector types:

- 3.5 mm
- type-N 50  $\Omega$
- 7 mm
- type-N 75  $\Omega$
- 7-16
- type-F

For information about connector-type options, refer to “[HP 8509X Series Module ECal Kit Contents](#)” on page 1-5, and “[HP 8506X Series Module ECal Kit Contents](#)” on page 1-6.

This manual also provides replacement part numbers, specifications and procedures for using, maintaining and troubleshooting the ECal modules and their related equipment.

For clarification only, this manual refers to the HP 8509X family as RF modules and the HP 8506X family as microwave modules.

---

### NOTE

ECal modules can be controlled using an HP 85060C control unit, or a combination of the HP 85097A PC interface module and a customer supplied PC.

Refer to the *Electronic Calibration System User's Guide* (HP part number 85091-90007) for information about the HP 85097A PC interface system.

Refer to the *HP 85060C Electronic Calibration Control Unit Operating, Programming and Service Manual* (HP part number 85060-90002) for information about the HP 85060C control unit.

---

## Prerequisite Knowledge

This manual assumes you know proper connector care. Refer to the “Principles of Microwave Connector Care Quick Reference Card,” located at the back of this manual. If another copy is needed, refer to [Chapter 4, “Replaceable Parts”](#) for the HP part number. You can also contact the nearest HP sales or service office for the customer training

course: “Understanding Connectors Used with Network Analyzers.”  
The courses available are:

- HP 85050A + 24A (on-site)
- HP 85050A + 24D (at HP sales office)

## Compatible Vector Network Analyzers

The ECal modules are supported by the following vector network analyzers (VNAs):

**Table 1-1 Supported Vector Network Analyzers**

Vector Network Analyzer	Firmware Revision
HP 8753C	4.13
HP 8753D	6.14 or higher
HP 8753E	7.12 or higher
HP 8510B	6.54
HP 8510C	7.00 or higher
HP 8719C	1.05
HP 8719D	6.14 or higher
HP 8720C	1.05
HP 8720D	6.14 or higher
HP 8722C	1.05
HP 8722D	6.14 or higher
HP 8753ES	7.60 or higher
HP 8753ET <sup>1</sup>	7.60 or higher
HP 8719ES	7.60 or higher
HP 8719ET <sup>1</sup>	7.60 or higher
HP 8720ES	7.60 or higher
HP 8720ET <sup>1</sup>	7.60 or higher
HP 8722ES	7.60 or higher
HP 8722ET <sup>1</sup>	7.60 or higher

1. ET model analyzers do not have the capability to accommodate full 2-port calibrations. Therefore, the only ECal calibration selection valid for these analyzers is “S11 1-Port” which is equivalent to selecting “Reflection 1-Port” on an ET analyzer.



## Incoming Inspection

Refer to the “[HP 8509X Series Module ECal Kit Contents](#)” on page 1-5, and “[HP 8506X Series Module ECal Kit Contents](#)” on page 1-6 to verify the complete shipment of your ECal kit.

To verify electrical performance of the modules in this kit, refer to the *Electronic Calibration System User's Guide* (HP part number 85091-90007).

If the case or any device appears damaged, contact the nearest Hewlett-Packard sales or service office listed in “[Service and Support](#)” on page 1-9 of this manual. Hewlett-Packard will arrange for repair or replacement of incomplete or damaged shipments without waiting for settlement from the transportation company.

## Equipment Recommended but Not Supplied

It is recommended that whenever possible, pin-depth gauge sets are used with the HP 8509X and HP 8506X. Gauges and connector cleaning supplies are not provided in this kit. Refer to [Chapter 4, “Replaceable Parts”](#) in this manual for ordering information.

## HP 8509X Series Module ECal Kit Contents

**Table 1-2 HP 8509X Series Module ECal Kit Contents**

<b>Kit Model Number and Type</b>	<b>Operating Frequency <sup>1</sup></b>	<b>Manuals Included</b>	<b>Torque Wrench and Torque Weight</b>	<b>Other Tools</b>
HP 85091A, 7 mm Kit	30 kHz to 6 GHz Calibration Module	ECal Module Reference Guide	3/4 inch, 135 N-cm (12 in-lb) torque wrench for use on the 7 mm connectors	7 mm collet extraction tool
HP 85092A, Type-N 50 Ω Kit	30 kHz to 6 GHz Calibration Module	ECal Module Reference Guide	3/4 inch, 135 N-cm (12 in-lb) torque wrench for use on the type-N 50 Ω connectors	
HP 85093A, 3.5 mm Kit	30 kHz to 6 GHz Calibration Module	ECal Module Reference Guide	20 mm, 90 N-cm (8 in-lb) torque wrench for use on the 3.5 mm connectors	
HP 85096A, Type-N 75 Ω Kit	30 kHz to 3.0 GHz Calibration Module	ECal Module Reference Guide		
HP 85098A, 7-16 Kit	30 kHz to 7.5 GHz Calibration Module	ECal Module Reference Guide	1 1/16 inch, 226 N-cm (20 inch-lb) torque wrench for use on the 7-16 connectors	15/16 inch open end wrench
HP 85099A, Type-F Kit	30 kHz to 3.0 GHz Calibration Module	ECal Module Reference Guide		12 mm open end wrench

1. RF ECal kits have specified performance from 300 kHz, but will operate with typical performance down to 30 kHz.

### HP 8509X Series Options Available

These options do not apply to the HP 85091A.

- Option 00M replaces the standard male and female module connectors with two male connectors.
- Option 00F replaces the standard male and female module connectors with two female connectors.
- Option 00A adds one male-to-male adapter, and one female-to-female adapter. A torque wrench is added to the 3.5 mm kit for use with the male-to-male adapter.

## HP 8506X Series Module ECal Kit Contents

**Table 1-3** HP 8506X Series ECal Kit Contents

<b>Kit Model Number and Type</b>	<b>Operating Frequency</b>	<b>Manuals and Software Included</b>	<b>Torque Wrench and Torque Weight</b>	<b>Other Tools</b>
HP 85060B 7 mm Kit	1 to 18 GHz Calibration Module	ECal Module Reference Guide Specification/Verification Program Disks	3/4 inch, 135 N-cm (12 in-lb) torque wrench for use on the 7mm connectors	7 mm collet extraction tool
HP 85062B 3.5 mm Kit	1 to 26.5 GHz Calibration Module	ECal Module Reference Guide Specification/Verification Program Disks	20 mm, 90 N-cm (8 in-lb) torque wrench for use on the 3.5 mm connectors	
HP 85064B Type-N 50 $\Omega$	1 to 18 GHz Calibration Module	ECal Module Reference Guide Specification/Verification Program Disks	3/4 inch, 135 N-cm (12 in-lb) torque wrench for use on the type-N 50 $\Omega$ connectors	

### HP 8506X Series Options Available

- Option 001 adds an RF (30 kHz to 6 GHz) calibration module.

The following options do not apply to the HP 85060B:

- Option 00M replaces the standard male and female module connectors with two male connectors.
- Option 00F replaces the standard male and female module connectors with two female connectors.
- Option 00A adds to the one male-to-male adapter, and one female-to-female adapter. A torque wrench is added to the 3.5 mm kit for use with the male-to-male adapter.

## Serial Numbers

A serial number label, similar to the one shown in [Figure 1-1](#), is attached to the calibration kit. The serial number uses the form US3444 1234.

- The first six digits form the serial number prefix (the first two digits are a country code, the next four are a year/week designation).
- The last four digits form the suffix (a simple counting sequence).

**Figure 1-1** Typical ECal Kit Serial Number Label

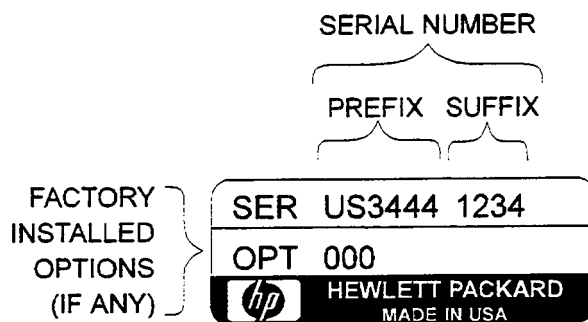

In addition to the kit serial number, the calibration modules in each kit are individually serialized. For your convenience, the following table has been created for you to record these serial numbers. Recording the serial numbers helps maintain the integrity of your kit. Kit integrity is an important part of compliance with U.S. MIL-STD-45662A.

Microwave modules with serial numbers below 800 will need to be retrofitted for operation with the new ECal system. The retrofitting must be done by a qualified HP service office. Refer to [“Service and Support” on page 1-9](#) of this manual for contact information.

**Table 1-4** ECal Kit and Individual Component Serial Numbers

Model Number	Serial Number

## Shipping Instructions

If the instrument is being returned to Hewlett-Packard for service, please include a service information tag (located at the end of this manual), or provide the following information:

- Your company name and address
- A technical contact person within your company, and the person's complete telephone number
- The model number and serial number of the kit if you are returning a complete kit
- The part numbers and serial numbers of the devices if you are returning individual components of the kit
- Type of service required
- Any other applicable information

The foam-lined storage case in which the kit was shipped provides protection during shipping. If you need replacement shipping supplies, contact the nearest HP sales and service office for part numbers.

---

## **Service and Support**

Any adjustment, maintenance, or repair of this product must be performed by qualified personnel. Contact a customer engineer through the nearest HP service center. You can find a list of HP service centers on the web at <http://www.hp.com/go/tmdir>.

If you do not have access to the Internet, one of these HP centers can direct you to your nearest HP representative:

**Hewlett-Packard Sales and Service Offices**

<b>UNITED STATES</b>		
<p>Instrument Support Center Hewlett-Packard Company (800) 403-0801</p>		
<b>EUROPEAN FIELD OPERATIONS</b>		
<p>Headquarters Hewlett-Packard S.A. 150, Route du Nant-d'Avril 1217 Meyrin 2/ Geneva Switzerland (41 22) 780.8111</p>	<p>France Hewlett-Packard France 1 Avenue Du Canada Zone D'Activite De Courtaboeuf F-91947 Les Ulis Cedex France (33 1) 69 82 60 60</p>	<p>Germany Hewlett-Packard GmbH Hewlett-Packard Strasse 61352 Bad Homburg v.d.H Germany (49 6172) 16-0</p>
<p>Great Britain Hewlett-Packard Ltd. Eskdale Road, Winnersh Triangle Wokingham, Berkshire RG41 5DZ England (44 118) 9696622</p>		
<b>INTERCON FIELD OPERATIONS</b>		
<p>Headquarters Hewlett-Packard Company 3495 Deer Creek Rd. Palo Alto, CA 94304-1316 USA (415) 857-5027</p>	<p>Australia Hewlett-Packard Australia Ltd. 31-41 Joseph Street Blackburn, Victoria 3130 (61 3) 895-2895</p>	<p>Canada Hewlett-Packard (Canada) Ltd. 17500 South Service Road Trans-Canada Highway Kirkland, Quebec H9J 2X8 Canada (514) 697-4232</p>
<p>Japan Hewlett-Packard Japan, Ltd. 9-1 Takakura-Cho, Hachioji Tokyo 192, Japan (81 426) 60-2111</p>	<p>Singapore Hewlett-Packard Singapore (Pte.) Ltd. 150 Beach Road #29-00 Gateway West Singapore 0718 (65) 291-9088</p>	<p>Taiwan Hewlett-Packard Taiwan 8th Floor, H-P Building 337 Fu Hsing North Road Taipei, Taiwan (886 2) 712-0404</p>
<p>China China Hewlett-Packard Co. 38 Bei San Huan X1 Road Shuang Yu Shu Hai Dian District Beijing, China (86 1) 256-6888</p>		

---

## Safety and Regulatory Information

Review this product and related documentation to familiarize yourself with safety markings and instructions before you operate the instrument. This product has been designed and tested in accordance with international standards.

---

### WARNING

**The WARNING notice denotes a hazard. It calls attention to a procedure, practice, or the like, that, if not correctly performed or adhered to, could result in personal injury. Do not proceed beyond a WARNING notice until the indicated conditions are fully understood and met.**

---

### CAUTION









The CAUTION notice denotes a hazard. It calls attention to an operating procedure, practice, or the like, which, if not correctly performed or adhered to, could result in damage to the product or loss of important data. Do not proceed beyond a CAUTION notice until the indicated conditions are fully understood and met.

---



## Instrument Markings

---

	When you see this symbol on your instrument, you should refer to the instrument's instruction manual for important information.
	This symbol indicates hazardous voltages.
	The laser radiation symbol is marked on products that have a laser output.
	This symbol indicates that the instrument requires alternating current (ac) input.
	The CE mark is a registered trademark of the European Community. If it is accompanied by a year, it indicates the year the design was proven.
	The CSA mark is a registered trademark of the Canadian Standards Association.
ISM1-A	This text indicates that the instrument is an Industrial Scientific and Medical Group 1 Class A product (CISPER 11, Clause 4).
	This symbol indicates that the power line switch is ON.
	This symbol indicates that the power line switch is OFF or in STANDBY position.
 <b>N279</b>	The C-Tick mark is a registered trademark of the Australian Spectrum Management Agency.

---

## Compliance Notices

### Compliance With German Noise Requirements

This is to declare that this instrument is in conformance with the German Regulation on Noise Declaration for Machines (Laermangabe nach der Maschinenlaermrrordnung -3.GSGV Deutschland).

---

#### Acoustic Noise Emission/Geraeuschemission

---

LpA <70 dB Operator position Normal position per ISO 7779	LpA <70 dB am Arbeitsplatz normaler Betrieb nach DIN 45635 t.19
--	--

---

### Compliance With EEC Directives

See the declaration of conformity on the following page.

## DECLARATION OF CONFORMITY

According to ISO/IEC Guide 22 and EN 45014

**Manufacturer's Name:** Hewlett-Packard Co.

**Manufacturer's Address:** 1400 Fountaingrove Parkway  
Santa Rosa, CA 95403-1799

Declares that the product:

**Product Name:** Electronic Calibration Modules

**Model Number:** HP 85091A, HP 85092A, HP 85093A,  
HP 85096A, HP 85098A, HP 85099A  
HP 85060B, HP 85062B, HP 85064B

**Product Options:** This declaration covers all options of the above products.

Conform to the following Product specifications:

**Safety:** IEC 61010-1:1990 / EN 61010-1:1993  
CAN/CSA-C22.2 No. 1010.1-92

**EMC:** CISPR 11:1990/EN 55011:1991 Group 1, Class A  
IEC 801-2:1984/EN 50082-1:1992 4 kV CD, 8 kV AD  
IEC 801-3:1984/EN 50082-1:1992 3 V/m, 27-500 MHz  
IEC 801-4:1988/EN 50082-1:1992 0.5 kV sig. lines, 1 kV power lines

### Supplementary Information:

The products herewith comply with the requirements of the Low Voltage Directive 73/23/EEC and the EMC Directive 89/336/EEC and carry the CE-marking accordingly.

These modules were tested with HP 85097A PC Interface Kit and HP Network Analyzers.



Santa Rosa, CA, USA 25 June 1999

Greg Pfeiffer/Quality Engineering Manager

European Contact: Your local Hewlett-Packard Sales and Service Office or Hewlett-Packard GmbH Department HQ-TRE, Herreneberger Strasse 130, D71034 Boblingen, Germany (FAX +49-7031-14-3143)

---

**2**

**Specifications and  
Characteristics**

---

## Specifications: Terminology and Definitions

The following terms and definitions are for both RF and microwave ECal kits. The definitions are intended to help clarify terms used in the specifications. The definitions are specific to these kits and are not necessarily valid definitions for other Hewlett-Packard products.

**Table 2-1** Specifications and Characteristics Terminology

<b>Terms</b>	<b>Definitions</b>
<b>Operating Temperature Range</b>	This is the temperature range over which the calibration standards maintain performance to their specifications.
<b>Error-corrected Temperature Range</b>	This is the allowable vector network analyzer (VNA) ambient temperature drift during measurement calibration and during measurements when VNA correction is turned on. It is also the range over which the VNA maintains its specified performance while correction is turned on. If this temperature range is exceeded, the error-corrected performance of the VNA is degraded.
<b>Measurement Calibration</b>	This calibration determines the corrections necessary for accuracy-enhanced (correction on) measurements.
<b>Connector Pin Depth Values</b>	Pin depth is a relative measurement value between the center conductor and outer conductor mating surfaces. All references to pin depth in this manual treat positive (+) values as protrusions of the center conductor, and negative (-) values as recessions of the center conductor. Refer to <a href="#">Figure 2-1 on page 2-6</a> for an explanation of the measured areas, and " <a href="#">Connector Pin Depth Information</a> " on <a href="#">page 2-8</a> for actual measurement values.
<b>References to Connector Sex</b>	In this manual, adapters, calibration modules, and gauge masters are referred to by the sex of their connector: a male adapter has a male connector. A gauge is referred to by the sex of the connector that it measures: a male gauge measures male connectors. A male gauge has a corresponding female connector.

## Environmental Specifications

**Table 2-2** Environmental Specifications for ECal Modules

Specifications	Limits
Operating Temperature Range	+20 to +26 °C (+68 to +79 °F)
Error-corrected Temperature Range	±1 °C of measurement calibration temperature
Storage Temperature	-40 to +75 °C (-40 to +167 °F)
Barometric Pressure (Altitude) <sup>1</sup>	
Operation	<4,500 meters (15,000 feet)
Storage	<15,000 meters (50,000 feet)
Relative Humidity	<i>Non-condensing at all times</i>
Operation	0% to 80% (at 26 °C maximum dry bulb)
Storage	0% to 95% (at 26 °C maximum dry bulb)
EMI	
Conducted Susceptibility	CETM 765
Radiated Susceptibility	EN 50082-1/IEC 801-3
Radiated Emissions	CISPR11
Magnetic Emissions	CETM 765

1. It should be noted that the HP 85097A PC interface is not warranted for use above 3000 meters (10,000 feet).

## Operating Temperature and Accuracy Enhancement

The operating temperature of the calibration module is important because device dimensions (and therefore electrical characteristics) change with temperature. The temperature of the calibration devices and all connectors must be stable, and must be within the operating limits given in [Table 2-2 on page 2-3](#) before use.

Measurement calibration, performance verification, and actual device measurements must be made within  $\pm 1^\circ\text{C}$  of the error corrected operating temperature range specification of the VNA.

If the ambient operating temperature drift of the VNA exceeds the allowable error corrected temperature range, a new measurement calibration must be performed to ensure optimum accuracy.

---

### NOTE

Remember that your fingers are a heat source, so avoid unnecessary handling of the module, connectors and cables.

---

## Barometric Pressure and Relative Humidity

Barometric pressure and relative humidity also affect device performance. The dielectric constant of the air between the inner and outer conductors of these devices changes as the air pressure and humidity change. Refer to [Table 2-2](#) for environmental specifications that include barometric pressure guidelines.

---

## Mechanical Characteristics

### Center Conductor Pin Depth

Mechanical characteristics, such as center conductor protrusion and pin depth, are not performance specifications. They are however, important supplemental characteristics related to the electrical performance of devices.

Hewlett-Packard verifies the mechanical characteristics of the devices in this kit with special gauging processes and electrical testing. These processes ensure that the device connectors do not exhibit any excess center conductor protrusion and have the proper pin depth when the kit leaves the factory.

### Pin Depth

Pin depth is the distance the center conductor mating plane differs from being flush with the outer connector mating plane (see [Figure 2-1 on page 2-6](#)). The pin depth of a connector can be in one of two states: either protruding or recessed.

---

**NOTE**

No protrusion of the center conductor shoulder is allowable on any 7 mm connector when the slotted collet is removed. The slotted collet must be removed before measuring the pin depth.

---

**Protrusion** occurs when the center conductor extends beyond the outer conductor mating plane. It reads as a positive value on the connector gauge.

**Recession** occurs when the center conductor is set back from the outer conductor mating plane. It reads as a negative value on the gauge.

---

**NOTE**

The center conductor protrusion or recession is referenced to the outer conductor mating plane.

---

**Figure 2-1 Type-N Connector Protrusion and Recession**

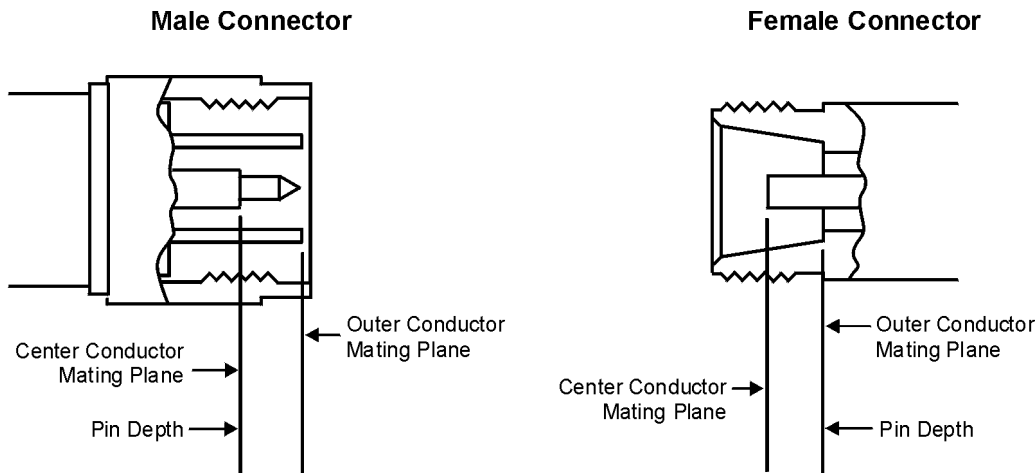

kl31a

### Electrical Performance

The electrical performance of any connector is affected by its pin depth. The electrical specifications for each module takes into account the effect of pin depth on the device's performance. See the tables under [“Connector Pin Depth Information” on page 2-8](#) for a list of typical pin depths and customer measurement uncertainties. The tables also provide observed pin depth limits for the devices in the kit. If the pin depth of a device is not within these limits, the device may fail to meet electrical specifications.

### Type-N 50 $\Omega$ and Type-N 75 $\Omega$ Connector Characteristics

Type-N connectors differ from most other connector types in that the outer conductor mating plane is offset from the mating plane of the center conductor (see [Figure 2-1](#)). The outer conductor in the male connector extends in front of the shoulder of the male contact pin. When you make a connection, this outer conductor fits into a recess in the female outer conductor behind the plane defined by the tip of the female contact fingers.

In type-N connectors, the shoulder position of the male contact pin (not the position of the tip) defines the position of the center conductor. The male contact pin slides into the female contact fingers; the inside surfaces of the tip of the female contact fingers on the sides of the male contact pin provide electrical contact.



### Critical Type-N Mechanical Characteristics

- **Minimum protrusion** of the female center conductor in front of the outer conductor mating plane is 5.182 mm or 0.204 inches.
- **Maximum protrusion** of the female center conductor in front of the outer conductor mating plane is 5.258 mm or 0.207 inches.
- **Minimum recession** of the shoulder of the male contact pin behind the outer conductor mating plane is 5.258 mm to 0.207 inches.
- **Maximum recession** of the shoulder of the male contact pin behind the outer conductor mating plane is 5.334 mm or 0.210 inches.

In the HP precision specification for type-N connectors, the minimum allowable recession for the male contact pin shoulder is 0.001 inches less than in the MIL-C-39012, Class II specification. Hewlett-Packard type-N pin depth gauges set “zero” on the gauge to be equal to a nominal 5.258 mm (0.207 inches) offset.

As type-N connectors wear, the protrusion of the female contact-fingers generally increases. This is due to the wear of the outer conductor mating plane inside the female connector. It is necessary to check this periodically as it decreases the total center conductor contact separation.

---

#### CAUTION

Never use a type-N connector if the possibility of interference between the shoulder of the male contact pin and the tip of the female contact fingers exists.

If you use both 75  $\Omega$  and 50  $\Omega$  type-N connectors, mark the 75  $\Omega$  connectors so that they are never accidentally mated with 50  $\Omega$  connectors. The diameter of the center conductor, male contact pin, and female contact hole are smaller on 75  $\Omega$  connectors.

Irreparable damage will occur if a male 50  $\Omega$  type-N connector is mated to a female 75  $\Omega$  type-N connector.

---

## Connector Pin Depth Information<sup>1</sup>

**Table 2-3 3.5 mm Connector Pin Depth Limits**

Device	Typical Pin Depth in micrometers (10 <sup>-4</sup> inches)	Measurement Uncertainty <sup>1</sup> in micrometers (10 <sup>-4</sup> inches)	Observed Pin Depth Limits in micrometers (10 <sup>-4</sup> inches)
3.5 mm ECal Module	-25.4 to -50.8 (-10.0 to -20.0)	+1.3 to -1.3 (+0.5 to -0.5)	-24.1 to -52.1 (-9.5 to -20.5)
3.5 mm Adapter	-2.5 to -13.0 (-1.0 to -5.0)	+1.3 to -1.3 (+0.5 to -0.5)	-1.2 to -14.3 (-0.5 to -5.5)

1. Approximately +2 sigma to -2 sigma of gauge uncertainty based on studies performed at the factory using analog gauges according to recommended procedures.

**Table 2-4 7 mm Connector Pin Depth Limits**

Device	Typical Pin Depth in micrometers (10 <sup>-4</sup> inches)	Measurement Uncertainty <sup>1</sup> in micrometers (10 <sup>-4</sup> inches)	Observed Pin Depth Limits in micrometers (10 <sup>-4</sup> inches)
7 mm ECal Module	-25.4 to -50.8 (-10.0 to -20.0)	+1.3 to -1.3 (+0.5 to -0.5)	-24.1 to -52.1 (-9.5 to -20.5)

1. Approximately +2 sigma to -2 sigma of gauge uncertainty based on studies performed at the factory using analog gauges according to recommended procedures.

**Table 2-5 Type-N 50 Ω Connector Pin Depth Limits**

Device	Typical Pin Depth <sup>1</sup> in micrometers (10 <sup>-4</sup> inches)	Measurement Uncertainty <sup>2</sup> in micrometers (10 <sup>-4</sup> inches)	Observed Pin Depth Limits in micrometers (10 <sup>-4</sup> inches)
Type-N 50 Ω ECal Module	-25.4 to -50.8 (-10.0 to -20.0)	+3.8 to -3.8 (+1.5 to -1.5)	-21.6 to -54.6 (-8.5 to -21.5)
Type-N 50 Ω Adapter	0 to -12.7 (0 to -5.0)	+3.8 to -3.8 (+1.5 to -1.5)	+3.8 to -16.5 (+1.5 to -6.5)

1. Measured from a 5.258 mm (0.207 inches) nominal offset.  
2. Approximately +2 sigma to -2 sigma of gauge uncertainty based on studies performed at the factory using analog gauges according to recommended procedures.

1. Hewlett-Packard does not supply pin depth gauges for type-F or 7-16 connectors. The type-F module adapter pin depth is set at -25.4 to -50.8 micrometers. The 7-16 module adapter pin depth is set at 0 to -38.1 micrometers recessed from the nominal 1.77 mm offset between inner conductor and outer conductor mating planes.

**Table 2-6                      Type-N 75 Ω Connector Pin Depth Limits**

<b>Device</b>	<b>Typical Pin Depth<sup>1</sup> in micrometers (10<sup>-4</sup> inches)</b>	<b>Measurement Uncertainty<sup>2</sup> in micrometers (10<sup>-4</sup> inches)</b>	<b>Observed Pin Depth Limits in micrometers (10<sup>-4</sup> inches)</b>
Type-N 75 Ω ECal Module	-25.4 to -50.8 (-10.0 to -20.0)	+3.8 to -3.8 (+1.5 to -1.5)	-21.6 to -54.6 (-8.5 to -21.5)
Type-N 75 Ω Adapter	0 to -76.2 (0 to -30.0)	+3.8 to -3.8 (+1.5 to -1.5)	+3.8 to -80.0 (+1.5 to -31.5)

1. Measured from a 5.258 mm (0.207 inches) nominal offset.
2. Approximately +2 sigma to -2 sigma of gauge uncertainty based on studies performed at the factory using analog gauges according to recommended procedures.

## Characteristics and Specifications

Both RF and microwave ECal module electrical specifications are provided in the following tables. Look for the table that defines your system. Make certain you recognize whether you are reading the correct tables for RF ECal or microwave ECal.

### Measurement Port Characteristics

**Table 2-7 HP 85091A RF 7 mm ECal**

HP 85091A	Frequency Range			
<b>Residual</b>	30 to 300 kHz (typical)	0.3 to 300 MHz	0.3 to 3 GHz	3 to 6 GHz
<b>Directivity (dB)</b>	- 52	- 52	- 56	- 55
<b>Source Match (dB)</b>	- 45	- 45	- 45	- 42
<b>Reflection Tracking (<math>\pm</math> dB)</b>	$\pm$ 0.050	$\pm$ 0.038	$\pm$ 0.038	$\pm$ 0.068
<b>Transmission Tracking (<math>\pm</math> dB)</b>	$\pm$ 0.140	$\pm$ 0.060	$\pm$ 0.055	$\pm$ 0.085
<b>Load Match (dB)</b>	- 41	- 48	- 47	- 46

**Table 2-8 HP 85060B Microwave 7 mm ECal**

HP 85060B	Frequency Range		
<b>Residual</b>	1 to 2 GHz	2 to 8 GHz	8 to 18 GHz
<b>Directivity (dB)</b>	- 50	- 49	- 46
<b>Source Match (dB)</b>	- 46	- 45	- 40
<b>Reflection Tracking (<math>\pm</math> dB)</b>	$\pm$ 0.032	$\pm$ 0.046	$\pm$ 0.065
<b>Transmission Tracking (<math>\pm</math> dB)</b>	$\pm$ 0.043	$\pm$ 0.050	$\pm$ 0.140
<b>Load Match (dB)</b>	- 46	- 44	- 40
<b>Option 001</b>	Add RF ECal Module (30 kHz to 6 GHz)	See HP 85091A specifications	

**Table 2-9 HP 85092A RF Type-N 50 Ω ECal**

HP 85092A	Frequency Range			
<b>Residual</b>	30 to 300 kHz (typical)	0.3 to 300 MHz	0.3 to 3 GHz	3 to 6 GHz
<b>Directivity (dB)</b>	- 52	- 52	- 54	- 52
<b>Source Match (dB)</b>	- 45	- 45	- 45	- 42
<b>Reflection Tracking (± dB)</b>	± 0.050	± 0.037	± 0.037	± 0.068
<b>Transmission Tracking (± dB)</b>	± 0.140	± 0.060	± 0.055	± 0.090
<b>Load Match (dB)</b>	- 41	- 48	- 47	- 44

**Table 2-10 HP 85064B Microwave Type-N 50 Ω ECal**

HP 85064B	Frequency Range		
<b>Residual</b>	1 to 2 GHz	2 to 8 GHz	8 to 18 GHz
<b>Directivity (dB)</b>	- 50	- 49	- 46
<b>Source Match (dB)</b>	- 46	- 45	- 40
<b>Reflection Tracking (± dB)</b>	± 0.034	± 0.046	± 0.065
<b>Transmission Tracking (± dB)</b>	± 0.043	± 0.050	± 0.140
<b>Load Match (dB)</b>	- 46	- 44	- 40
<b>Option 001</b>	Add RF ECal Module (30 kHz to 6 GHz)	See HP 85092A specifications	

**Table 2-11 HP 85093A RF 3.5 mm ECal**

HP 85093A	Frequency Range			
<b>Residual</b>	30 to 300 kHz (typical)	0.3 to 300 MHz	0.3 to 3 GHz	3 to 6 GHz
<b>Directivity (dB)</b>	- 52	- 50	- 52	- 50.5
<b>Source Match (dB)</b>	- 45	- 45	- 43.5	- 40
<b>Reflection Tracking (± dB)</b>	± 0.050	± 0.043	± 0.043	± 0.055
<b>Transmission Tracking (± dB)</b>	± 0.140	± 0.050	± 0.045	± 0.085
<b>Load Match (dB)</b>	- 41	- 48	- 47	- 44

**Table 2-12 HP 85062B Microwave 3.5 mm ECal**

HP 85062B	Frequency Range			
<b>Residual</b>	1 to 2 GHz	2 to 8 GHz	8 to 20 GHz	20 to 26.5 GHz
<b>Directivity (dB)</b>	- 48	- 49	- 46	- 44
<b>Source Match (dB)</b>	- 45	- 43	- 40	- 37
<b>Reflection Tracking (<math>\pm</math> dB)</b>	$\pm$ 0.041	$\pm$ 0.041	$\pm$ 0.064	$\pm$ 0.088
<b>Transmission Tracking (<math>\pm</math> dB)</b>	$\pm$ 0.048	$\pm$ 0.068	$\pm$ 0.130	$\pm$ 0.170
<b>Load Match (dB)</b>	- 45	- 43	- 40	- 38
<b>Option 001</b>	Add RF ECal Module (30 kHz to 6 GHz) See HP 85093A specifications			

**Table 2-13 HP 85096A RF Type-N 75  $\Omega$  ECal**

HP 85096A	Frequency Range			
<b>Residual</b>	30 to 300 kHz (typical)	0.3 to 300 MHz	0.3 to 1.3 GHz	1.3 to 3 GHz
<b>Directivity (dB)</b>	- 51	- 50	- 48	- 43
<b>Source Match (dB)</b>	- 45	- 48	- 45	- 38
<b>Reflection Tracking (<math>\pm</math> dB)</b>	$\pm$ 0.100	$\pm$ 0.032	$\pm$ 0.060	$\pm$ 0.100
<b>Transmission Tracking (<math>\pm</math> dB)</b>	$\pm$ 0.150	$\pm$ 0.075	$\pm$ 0.095	$\pm$ 0.160
<b>Load Match (dB)</b>	- 41	- 43	- 41	- 39

**Table 2-14 HP 85098A RF 7-16 ECal**

HP 85098A	Frequency Range			
<b>Residual</b>	30 to 300 kHz (typical)	0.3 to 300 MHz	0.3 to 3 GHz	3 to 7.5 GHz
<b>Directivity (dB)</b>	- 48	- 50	- 47	- 44
<b>Source Match (dB)</b>	- 45	- 47	- 43	- 36
<b>Reflection Tracking (<math>\pm</math> dB)</b>	$\pm$ 0.100	$\pm$ 0.032	$\pm$ 0.045	$\pm$ 0.075
<b>Transmission Tracking (<math>\pm</math> dB)</b>	$\pm$ 0.150	$\pm$ 0.055	$\pm$ 0.080	$\pm$ 0.170
<b>Load Match (dB)</b>	- 43	- 45	- 42	- 36

**Table 2-15 HP 85099A RF Type-F ECal<sup>1</sup>**

HP 85099A	Frequency Range			
<b>Residual</b>	30 to 300 kHz (typical)	0.3 to 300 MHz	0.3 to 1.3 GHz	1.3 to 3.0 GHz
<b>Directivity (dB)</b>	– 51	– 50	– 48	– 43
<b>Source Match (dB)</b>	– 45	– 48	– 45	– 38
<b>Reflection Tracking (± dB)</b>	± 0.100	± 0.032	± 0.065	± 0.150
<b>Transmission Tracking (± dB)</b>	± 0.150	± 0.075	± 0.100	± 0.170
<b>Load Match (dB)</b>	– 41	– 43	– 41	– 39

1. Pin diameter is 0.77 mm (0.030 in) to 0.86 mm (0.034 in).

**Table 2-16 HP 85099A RF Type-F ECal<sup>1</sup>**

HP 85099A	Frequency Range			
<b>Residual</b>	30 to 300 kHz (typical)	0.3 to 300 MHz (typical)	0.3 to 1.3 GHz (typical)	1.3 to 3.0 GHz (typical)
<b>Directivity (dB)</b>	– 40	– 48	– 43	– 32
<b>Source Match (dB)</b>	– 37	– 46	– 41	– 26
<b>Reflection Tracking (± dB)</b>	± 0.150	± 0.060	± 0.090	± 0.350
<b>Transmission Tracking (± dB)</b>	± 0.200	± 0.080	± 0.120	± 0.350
<b>Load Match (dB)</b>	– 37	– 43	– 40	– 29

1. Pin diameter is 0.56 mm (0.022 in) to 1.07 mm (0.042 in) (typical).

## Supplemental Characteristics

Characteristics provide you with useful information, but are not warranted as specifications. [Table 2-17](#) and [Table 2-18](#) list the electrical characteristics for ECal modules. [Table 2-19](#) on [page 2-15](#) lists the mechanical characteristics for ECal modules.

### Electrical Characteristics

**Table 2-17** 7 mm and 3.5 mm ECal Module Characteristics and Specifications

	HP 85091A <sup>1</sup>	HP 85060B	HP 85093A <sup>1</sup>	HP 85062B
<b>Frequency Standard</b>	30 kHz to 6 GHz	1 to 18 GHz	30 kHz to 6 GHz	1 to 26.6 GHz
<b>Option 001<sup>1, 2</sup></b>	N/A	30 kHz to 6 GHz	N/A	30 kHz to 6 GHz
<b>Maximum Power</b>	+20 dBm	+20 dBm	+20 dBm	+20 dBm
<b>Minimum Power<sup>3</sup></b>	- 45 dBm	- 45 dBm	- 45 dBm	- 45 dBm
<b>Connectors:</b>				
<b>Standard</b>	7 mm	7 mm	3.5 mm (m-f)	3.5 mm (m-f)
<b>Option 00F</b>	N/A	N/A	3.5 mm (f-f)	3.5 mm (f-f)
<b>Option 00M</b>	N/A	N/A	3.5 mm (m-m)	3.5 mm (m-m)

1. RF ECal modules are specified to operate from 300 kHz, with typical performance down to 30 kHz.
2. Option 001 adds an RF ECal module (30 kHz to 6 GHz) to the microwave (HP 8506X series) ECal module.
3. This is the typical power required at the port of the module used.

**Table 2-18** Type-N, 7-16 and Type-F ECal Module Characteristics and Specifications

	HP 85092A <sup>1</sup>	HP 85064B	HP 85096A <sup>1</sup>	HP 85098A <sup>1</sup>	HP 85099A <sup>1</sup>
<b>Frequency Standard</b>	30 kHz to 6 GHz	1 to 18 GHz	30 kHz to 3 GHz	30 kHz to 7.5 GHz	30 kHz to 3 GHz
<b>Option 001<sup>1, 2</sup></b>	N/A	30 kHz to 6 GHz	N/A	N/A	N/A
<b>Maximum Power</b>	+20 dBm	+20 dBm	+20 dBm	+20 dBm	+20 dBm
<b>Minimum Power<sup>3</sup></b>	- 45 dBm	- 45 dBm	- 45 dBm	- 45 dBm	- 45 dBm
<b>Connectors:</b>					
<b>Standard</b>	Type-N 50 Ω (m-f)	Type-N 50 Ω (m-f)	Type-N 75 Ω (m-f)	7-16 (m-f)	Type-F (m-f)
<b>Option 00F</b>	Type-N 50 Ω (f-f)	Type-N 50 Ω (f-f)	Type-N 75 Ω (f-f)	7-16 (f-f)	Type-F (f-f)
<b>Option 00M</b>	Type-N 50 Ω (m-m)	Type-N 50 Ω (m-m)	Type-N 75 Ω (m-m)	7-16 (m-m)	Type-F (m-m)

1. RF ECal modules are specified to operate from 300 kHz, with typical performance down to 30 kHz.
2. Option 001 adds an RF ECal module (30 kHz to 6 GHz) to the microwave (HP 8506X series) ECal module.
3. This is the typical power required at the port of the module used.



## Mechanical Characteristics

### HP 8509X RF ECal Kit

Table 2-19

HP 8509X Mechanical Characteristics

Characteristic	Limit
<b>Net Weight With Case:</b>	
Standard	2.7 kilograms (5.9 lbs)
<b>Shipping Weight:</b>	
Standard	4.3 kilograms (9.5 lbs)
<b>Shipping Dimensions:</b>	
Length	55.2 cm (21.75 inches)
Width	36.8 cm (14.5 inches)
Height	27.3 cm (10.75 inches)

### HP 8506X Microwave ECal Kit

Table 2-20

HP 8506X Mechanical Characteristics

Characteristic	Limits
<b>Net Weight With Case:</b>	
Standard	2.7 kilograms (5.9 lbs)
Option 001	3.3 kilograms (7.3 lbs)
<b>Shipping Weight:</b>	
Standard	4.3 kilograms (9.5 lbs)
Option 001	4.9 kilograms (10.8 lbs)
<b>Dimensions:</b>	
Length	55.2 cm (21.75 inches)
Width	36.8 cm (14.5 inches)
Height	27.3 cm (10.75 inches)

## Torque Wrench Information

### HP 8509X RF ECal

**Table 2-21 HP 8509X RF Ecal Torque Wrench Information**

<b>Torque Wrench Part Number<sup>1</sup></b>	<b>Wrench Opening</b>	<b>Connector Type</b>	<b>Torque Setting</b>	<b>Torque Tolerance<sup>2</sup></b>
8710-1764	20 mm	3.5 mm	90 N-cm (8 in-lb)	± 9 N-cm (± 0.8 in-lb)
8710-1765	5/16 in	3.5 mm	90 N-cm (8 in-lb)	± 9 N-cm (± 0.8 in-lb)
8710-1766	3/4 in	7 mm	135 N-cm (12 in-lb)	± 13.5 N-cm (± 1.2 in-lb)
8710-1766	3/4 in	Type-N 50 Ω	135 N-cm (12 in-lb)	± 13.5 N-cm (± 1.2 in-lb)
8710-1766 <sup>3</sup>	3/4 in	Type-N 75 Ω	135 N-cm (12 in-lb)	± 13.5 N-cm (± 1.2 in-lb)
8710-2174	1 1/16 in	7-16	226 N-cm (20 in-lb)	± 22.6 N-cm (± 2 in-lb)

1. A torque wrench is not included with the type-F kit. If a torque wrench is needed, use one with a wrench opening of 12 mm and a torque setting of 170 N-cm.
2. Many older HP calibration kit manuals list different torque tolerances for the various torque wrenches. The correct torque tolerance for HP torque wrenches is ±10% of the torque setting as listed in this table.
3. Recommended (but not supplied) with the HP 85096A.

### HP 8506X Microwave ECal

**Table 2-22 HP 8506X Microwave ECal Torque Wrench Information**

<b>Torque Wrench Part Number</b>	<b>Wrench Opening</b>	<b>Connector Type</b>	<b>Torque Setting</b>	<b>Torque Tolerance</b>
8710-1764	20 mm	3.5 mm	90 N-cm (8 in-lb)	± 9 N-cm (± 0.8 in-lb)
8710-1765	5/16 in	3.5 mm	90 N-cm (8 in-lb)	± 9 N-cm (± 0.8 in-lb)
8710-1766	3/4 in	7 mm	135 N-cm (12 in-lb)	± 13.5 N-cm (± 1.2 in-lb)
8710-1766	3/4 in	Type-N 50 Ω	135 N-cm (12 in-lb)	± 13.5 N-cm (± 1.2 in-lb)

---

## Warranty

Custom systems are warranted by contractual agreement between Hewlett-Packard Company and the customer.

## Certification

*Hewlett-Packard Company certifies that this product met its published specifications at the time of shipment from the factory. Hewlett-Packard further certifies that its calibration measurements are traceable to the United States National Institute of Standards and Technology (NIST, formerly NBS), to the extent allowed by the Institute's calibration facility, and to the calibration facilities of other International Standards Organization members.*

## Warranty

This Hewlett-Packard product is warranted against defects in materials and workmanship for a period of one year. During the warranty period, Hewlett-Packard Company will, at its option, either repair or replace products that prove to be defective.

Warranty service for products installed by HP and certain other products designated by HP will be performed at Buyer's facility at no charge within HP service travel areas. Outside HP service travel areas, warranty service will be performed at Buyer's facility only upon HP's prior agreement and Buyer shall pay HP's round trip travel expenses. In all other areas, products must be returned to a service facility designated by HP.

For products returned to HP for warranty service, Buyer shall prepay shipping charges to HP and HP shall pay shipping charges to return the product to Buyer. However, Buyer shall pay all shipping charges, duties, and taxes for products returned to HP from another country.

HP warrants that its software and firmware designated by HP for use with an instrument will execute its programming instructions when properly installed on that instrument. HP does not warrant that the operation of the instrument, or software, or firmware will be uninterrupted or error free.

**LIMITATION OF WARRANTY.** The foregoing warranty shall not apply to defects resulting from improper or inadequate maintenance by Buyer, Buyer-supplied software or interfacing, unauthorized modification or misuse, operation outside of the environmental specifications for the product, or improper site preparation or maintenance.

**NO OTHER WARRANTY IS EXPRESSED OR IMPLIED. HP SPECIFICALLY DISCLAIMS THE IMPLIED WARRANTIES OR**

MERCHANTABILITY AND FITNESS FOR A PARTICULAR PURPOSE.

**EXCLUSIVE REMEDIES.** THE REMEDIES PROVIDED HEREIN ARE BUYER'S SOLE AND EXCLUSIVE REMEDIES. HP SHALL NOT BE LIABLE FOR ANY DIRECT, INDIRECT, SPECIAL, INCIDENTAL, OR CONSEQUENTIAL DAMAGES, WHETHER BASED ON CONTRACT, TORT, OR ANY OTHER LEGAL THEORY.

### **Assistance**

Product maintenance agreements and other customer assistance agreements are available for Hewlett-Packard products.

For assistance, call the nearest Hewlett-Packard sales or service office (refer to ["Service and Support" on page 1-9](#)).

---

---

**3**

**Gauging and Making  
Connections**

## **Handling and Storage**

Handle and store the calibration devices with great care. Their continued performance and accuracy are dependent upon maintaining the precise mechanical tolerances of the connectors.

When the calibration modules are not in use, replace their protective end caps and store them in the foam-lined storage case. The storage case lid is detachable so that the case can be stored in a drawer.

---

## Electrostatic Discharge (ESD)

---

### CAUTION

Static electricity builds up on the body and can easily damage sensitive internal circuit elements when discharged by contact with the center conductor of the RF connector, or the center contacts of the 25 pin D-sub connector on any of the ECal modules.

---

The human body almost always retains some static charge. You are usually not aware of this charge because the human threshold for the perception of static discharge shock is approximately 3,000 volts. Electrostatic discharge as low as 60 volts can destroy sensitive microcircuits. When you clean or inspect connectors attached to any static-sensitive circuits (on the calibration module or any instrument), it is essential to protect against ESD.

- Always have a grounded antistatic mat in front of your test equipment and wear a grounded wrist strap attached to it. See [Figure 3-1 on page 3-4](#).
- Ground yourself before you clean, inspect, or make a connection to a static-sensitive device or test port. You can, for example, grasp the grounded outer shell of the test port briefly to discharge static from your body.
- Discharge static electricity from a device before connecting it by touching the device briefly (through a resistor of at least 1 M  $\Omega$ ) to either the outer shell of the test port connector or to another exposed ground source (such as a grounding receptacle). Discharging static electricity protects test equipment circuitry.

Refer to [Chapter 4, “Replaceable Parts”](#) for information about ordering supplies for ESD protection.

**Figure 3-1 ESD Protection Using Mat, Wrist Strap and Grounded Power Cord**

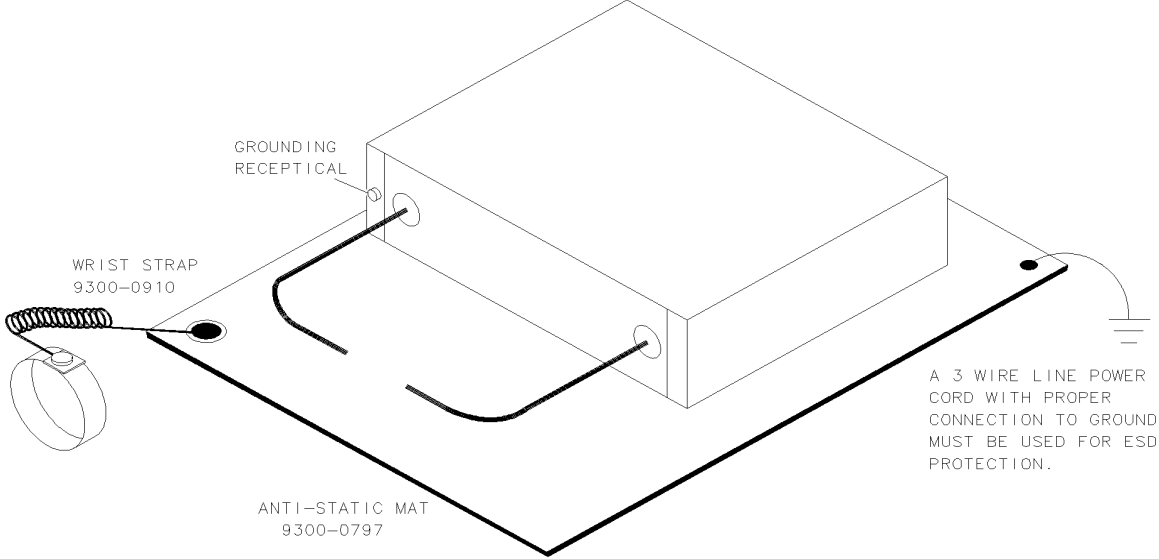

nostatic\_d



## Preventive Maintenance

The best techniques for maintaining the integrity of the devices in this kit include:

- routine visual inspection
- cleaning
- proper gauging
- proper connection techniques

Failure to detect and remove dirt or metallic particles on a connector mating plane surface can degrade repeatability and accuracy, and can damage any connector mated to it.

Improper connections, resulting from pin depth values being out of the “Observed Pin Depth Limits” (see [Table 2-3](#) through [Table 2-8](#)), or from using poor connection techniques, can also damage these devices.

Visual inspection, cleaning and proper connection techniques, along with proper gauging for pin depth, are all described in this chapter.

## Visual Inspection

Visual inspection and, if necessary, cleaning should be done every time a connection is made. Metal particles from the connector threads may fall into the connector when it is disconnected. One connection made with a dirty or damaged connector can damage both connectors beyond repair.

In some cases, magnification is necessary to see damage on a connector. This is especially true with female connectors. The contact fingers on the center conductor may become bent or broken. The use of a microscope with a magnification  $\geq 10\times$  is recommended to detect this type of damage. Not all defects that are visible only under magnification will affect the electrical performance of the connector. Use the following guidelines when evaluating the integrity of a connector.

### Look for Obvious Defects and Damage First

Examine the connectors first for obvious defects and damage: badly worn plating on the connector interface, deformed threads, or bent, broken, or misaligned center conductors. Connector nuts should move smoothly and be free of burrs, loose metal particles and rough spots.

Devices with damaged connectors should be discarded or repaired if possible. Try to determine the cause of damage before connecting a new, undamaged connector in the same configuration.

### Inspecting the Mating Plane Surfaces

Flat contact between the connectors at all points on their mating plane surfaces is required for a good connection. Look especially for deep scratches or dents, and for dirt and metal particles on the connector mating plane surfaces. Also look for bent or rounded edges on the mating plane surfaces of the center and outer conductors, and for signs of damage due to excessive or uneven wear or misalignment.

Light burnishing of the mating plane surfaces is normal, and is evident as light scratches or shallow circular marks distributed more or less uniformly over the mating plane surface. Other small defects and cosmetic imperfections are also normal. None of these affect electrical or mechanical performance.

If a connector shows deep scratches or dents, particles clinging to the mating plane surfaces, or uneven wear, clean and inspect it again. Devices with damaged connectors should be discarded. Try to determine the cause of damage before connecting a new, undamaged connector in the same configuration.

## Inspecting Slotless Connectors

When using slotless connectors like the 3.5 mm or type-N 50  $\Omega$  female connectors, pay special attention to the female center conductor contact fingers. These are easily bent or broken, and damage to them is not always easy to see. A connector with damaged contact fingers will not make good electrical contact and must be replaced.

---

NOTE

This is particularly important when you are mating nonprecision to precision devices.

---

## Checking for Connector Wear

Connector wear eventually degrades performance. The more use a connector gets, the faster it wears and degrades. This is especially true with electrically characterized devices such as ECal modules. The wear is greatly accelerated when connectors are not kept clean, or are connected incorrectly. Test port connectors on the VNA test set may have many connections each day, and are therefore subject to more wear. It is recommended that you use an adapter as a test-port saver to minimize the wear on the test set's test port connectors. Replace all worn connectors.

## Cleaning Connectors

---

**CAUTION**

If you must use a solvent, use only isopropyl alcohol. Use the smallest amount of alcohol possible, and avoid wetting any plastic parts in the connectors by tipping the connector at an angle downward.

---

For long, reliable connector life, carefully clean all connectors. If alcohol is used, check for dirty or contaminated alcohol before use, (see [“Checking for Alcohol Contamination”](#)). Refer to [Chapter 4, “Replaceable Parts”](#) for information on ordering recommended cleaning supplies.

### Checking for Alcohol Contamination

To check for alcohol contamination:

1. Let a few drops of your cleaning alcohol evaporate on a clean glass plate or microscope slide.
2. Examine the glass in reflected light. It should be perfectly clean and free of residue. If not, do not use the alcohol from that container.

Whenever you need to clean connectors, pour a small amount of alcohol into a clean container to use (this will keep your main supply of alcohol free of contamination). When you have finished cleaning the connectors, safely discard any remaining alcohol, and clean the container.

---

**WARNING**

**Isopropyl alcohol is extremely flammable, causes irritation, may cause eye damage, and is harmful if swallowed or inhaled. It may be harmful if absorbed through the skin. Keep away from heat, sparks, and flame. Avoid contact with eyes, skin, clothing. Avoid breathing vapor. Keep in tightly closed container. Use with adequate ventilation. Wash thoroughly after handling. In case of fire, use alcohol foam, dry chemical, or carbon dioxide: water may be ineffective. In case of spill, soak up with sand or earth. Flush spill area with water.**

**Dispose of isopropyl alcohol in accordance with all applicable federal, state, and local environmental regulations**

---

---

## General Cleaning Procedures

### Using Compressed Air or Nitrogen

---

**WARNING**

**Wear protective eye covering at all times when using compressed air or nitrogen.**

Use compressed air or nitrogen to loosen particles on the connector mating plane surfaces. Clean air cannot damage a connector or leave particles or residues behind.

You can use any source of clean, dry, low-pressure compressed air or nitrogen that has an effective oil-vapor filter and liquid condensation trap placed just before the outlet hose. Ground the hose nozzle to prevent electrostatic discharge, and set the air pressure to 414 kPa (60 psi) or less. High velocity air can cause electrostatic effects when directed into a connector.

### Cleaning the Connector Threads

---

**CAUTION**

This procedure assumes you have taken the necessary ESD precautions. Refer to [“Electrostatic Discharge \(ESD\)” on page 3-3](#) for a description of ESD precautions.

For dirt or stubborn contaminants on a connector that you cannot remove with compressed air or nitrogen, try a cleaning swab or lint-free cleaning cloth moistened with isopropyl alcohol.

To clean the connector threads:

1. Apply a small amount of isopropyl alcohol to a cleaning swab or lint-free cleaning cloth.
2. Clean the connector threads.
3. Let the alcohol evaporate, then blow the threads dry with a gentle stream of clean, low-pressure compressed air or nitrogen.

### Cleaning the Mating Plane and Interior Surfaces

Apply a small amount of isopropyl alcohol to a new cleaning swab and clean the mating plane and interior surfaces.

If the connector has a center conductor, use very short horizontal or vertical strokes (across the connector), and the least pressure possible,

especially when cleaning a female connector (to avoid snagging the swab on the center conductor contact fingers).

### **Drying the Connector**

After cleaning, blow the connector dry with a gentle stream of clean compressed air or nitrogen. Always completely dry a connector before you reassemble or use it.

### **Inspecting Each Connector Again**

Inspect the connector again under a magnifying glass to be sure that no particles or residues remain.

## **Precision 7 mm Connector Cleaning Procedure**

### **Cleaning the Center Collet While It Is in Place**

You do not have to remove the center conductor collet to clean a precision 7 mm connector.

With the center collet in place:

1. Place a lint-free cleaning cloth flat on a table.
2. Dispense a drop or two of isopropyl alcohol in the center of the cloth.
3. Retract the connector sleeve threads to expose the connector interface.
4. Gently press the contact end of the connector into the moistened cloth and rotate the connector. The cloth scrubs away dirt on the connector interface without damaging it.
5. Blow the connector dry with a gentle stream of compressed air or nitrogen.
6. When not in use, keep the cloth in a plastic bag or box so that it does not collect dust or dirt.

For fixed connectors (connectors attached to a device that cannot be freely moved):

1. Fold a lint-free cleaning cloth several times.
2. Moisten the cloth with isopropyl alcohol.
3. Press the moistened cloth against the connector interface and rotate the cloth to clean the connector.
4. Blow the connector dry with a gentle stream of compressed air or nitrogen.

### **Cleaning a Removed Center Collet**

Any time you remove the center conductor collet, clean and inspect the interior surfaces as described in [“General Cleaning Procedures”](#).

## Gauging Devices

Gauges are intended for preventive maintenance and troubleshooting purposes only. They are effective in detecting center conductor protrusion or excessive recession. Using gauges can be effective in preventing connector damage on devices-under-test (DUTs), test accessories, and the ECal modules.

---

**NOTE**

While performing pin depth measurements, use different orientations of the gauge with the connector. Average a minimum of three readings, each taken after a quarter-turn rotation of the gauge, to reduce measurement variations that result from the gauge or the connector face not being exactly perpendicular to the center axis.

---

## Gauge Accuracy

Hand held connector gauges are only capable of performing coarse measurements. They do not provide extremely precise measurements of pin depth. This is partially due to the repeatability uncertainties that are associated with pin-depth measurements. At the factory, with special gauging processes and electrical testing, the mechanical characteristics of devices can be accurately verified.

Even then, the resultant average can be in error by as much as 0.0001 inch due to systematic (biasing) errors usually resulting from worn gauges and gauge masters. As a result, these systematic errors are not included in the uncertainty analysis. As the gauges endure more use, the systematic errors could become more significant in the accuracy of the measurement.

## When to Gauge Connectors

You should gauge a connector:

- Before you use it for the first time. It is recommended that you record the initial pin depth measurement of your device for comparison with future readings. This serves as a good troubleshooting tool when you suspect damage may have occurred to the device.
- Whenever either visual inspection or electrical performance suggests that the connector interface may be out of typical range (due to wear or damage, for example).
- When someone else has used the calibration device, or if it has been used on another system or piece of equipment.



- As a matter of routine: initially after every 100 connections, and after that as often as experience suggests.

---

NOTE

When using the 7 mm ECal Kit module, you must remove the 7 mm collet *before* gauging the pin depth of the connectors. Refer to “[Gauging Techniques](#)” on page 3-22 for gauging instructions. Use the collet extraction tool provided in your 7 mm kit to remove the collet.

---

## Using Connector Gauges

Review the following information to understand how to read, adjust and zero connector gauges. If you are familiar with reading, adjusting and zeroing gauges already, you can move ahead to [“Making Connections” on page 3-18](#).

## Recognizing Gauge Types

Each type of connector uses a different connector gauge. For detailed descriptions of connector gauges,

- See [Figure 3-2 on page 3-15](#) for typical 3.5 mm gauges.
- See [Figure 3-3 on page 3-16](#) for typical 7 mm gauges.
- See [Figure 3-4 on page 3-17](#) for typical type-N gauges.

The gauges in all of the kits are screw-on type gauges. Every connector gauge requires a gauge calibration block to zero the gauge. A gauge is referred to by the sex of the connector it measures. For example, a male gauge measures male connectors and a male gauge has a corresponding female connector.

**Figure 3-2**      **Typical 3.5 mm Connector Gauge**

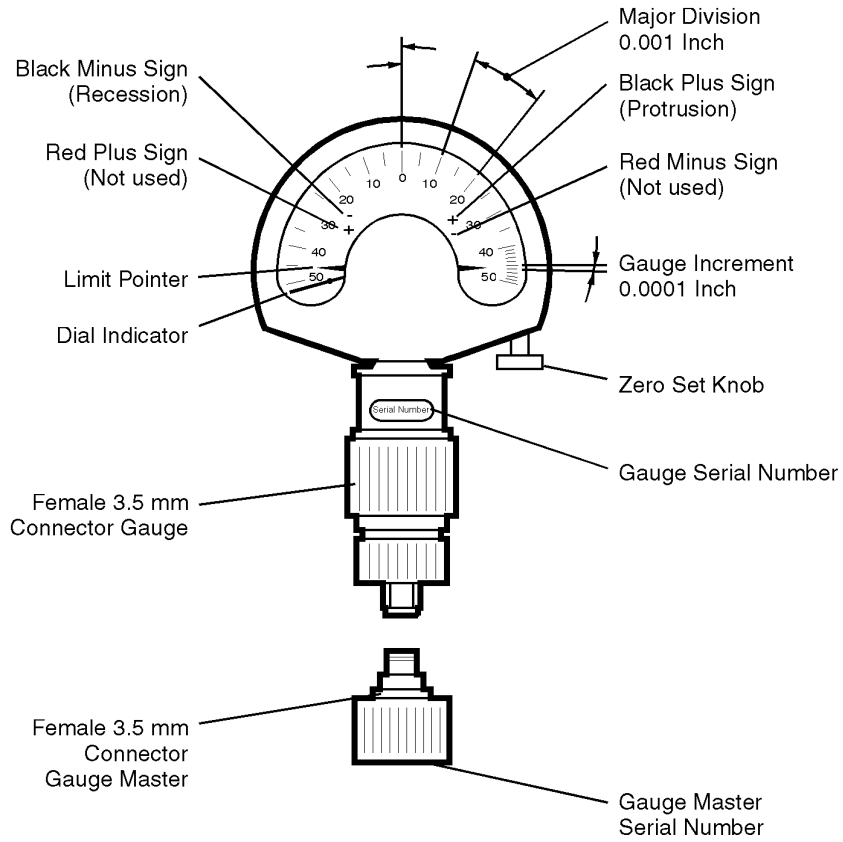

**Figure 3-3**      **Typical 7 mm Connector Gauge**

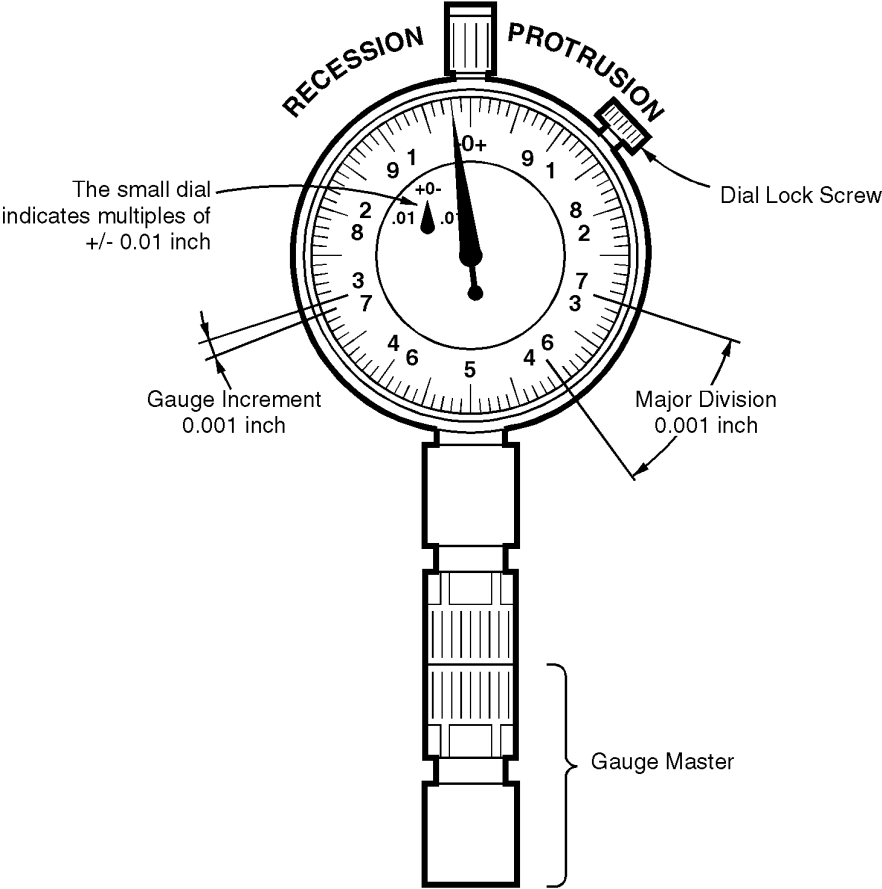

**Figure 3-4**      **Typical Type-N Connector Gauge**

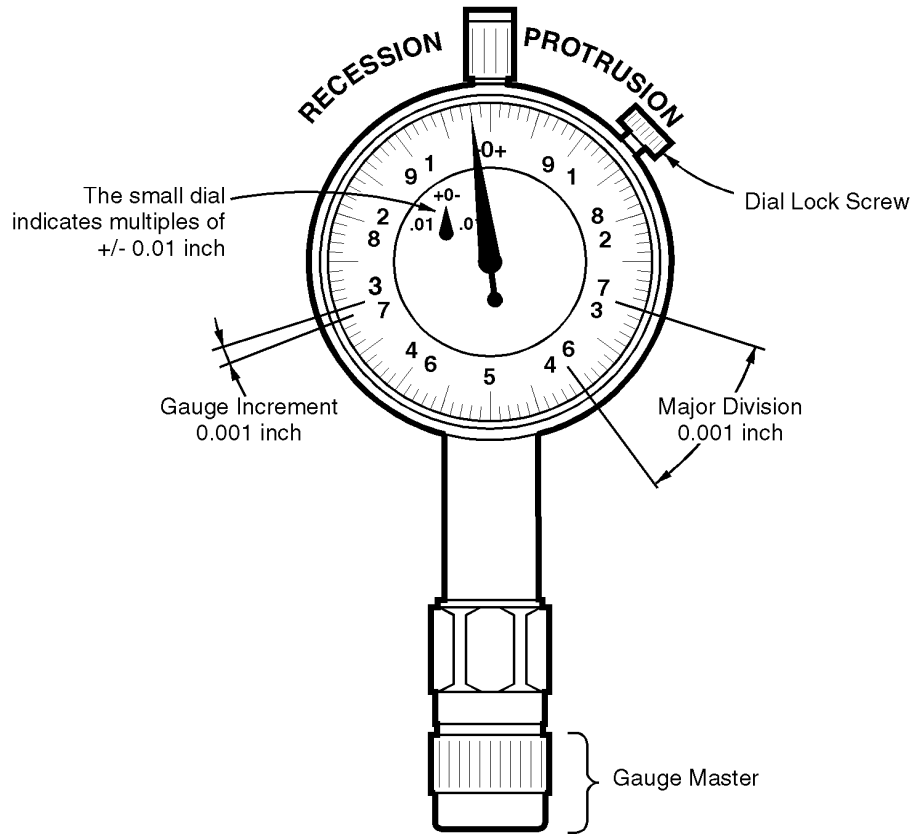

n50ohm

## Making Connections

Good connections are essential for accurate measurements. Operators must be very precise when making connections to ensure that accurate measurements are taken.

---

**CAUTION**

This procedure assumes that you have taken the necessary ESD precautions, and that you have already cleaned and inspected (visually and mechanically) the connectors. Refer to [“Electrostatic Discharge \(ESD\)” on page 3-3](#) for a description of ESD precautions.

---

**CAUTION**

You can damage the RF ECal modules if you apply excessive torque to the RF connectors. *Do not exceed* the recommended specifications listed on [“Torque Wrench Information” on page 2-16](#) when connecting and disconnecting RF ECal modules.

---

### Using a Torque Wrench

1. Hand tighten the connection to be torqued. Be sure to keep the connectors from rotating relative to each other. Turn the coupling nut only.

---

**CAUTION**

Rotating connectors relative to each other during the connect/disconnect cycle is the leading cause of connector wear.

2. Hold the torque wrench with your thumb and index finger behind the groove in the handle.
3. Tighten the connection until the handle begins to break loose. It is not necessary to fully break the handle of the torque wrench to reach the specified torque (see [Figure 3-5](#)).

Reverse the order to disconnect.

**Figure 3-5**      **Proper and Improper Torquing Methods**

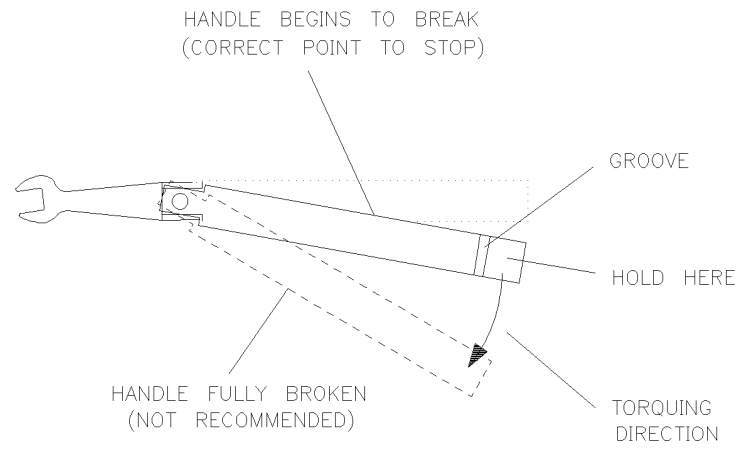

## Zeroing Connector Gauges

For type-N gauges, the paired gauge master is labeled with an offset value to compensate for its inaccuracy with its gauge. This label appears on the bottom of all type-N gauge masters that have been paired with gauges. When setting a type-N gauge with its master, always set the gauge to the master offset value shown on the label, not to zero, unless that is the offset value indicated.

The design of the 3.5 mm and 7 mm pin depth gauges are different than the type-N gauge design. The 3.5 mm and 7 mm gauges do not require any offsetting to compensate for inaccuracies in the gauge masters. For the locations of the gauge masters for the 3.5 mm, 7 mm, and type-N gauges, see [Figure 3-2 on page 3-15](#), [Figure 3-3 on page 3-16](#), and [Figure 3-4 on page 3-17](#).

---

### NOTE

Hold a connector gauge by the gauge barrel, below the dial indicator. This gives the best stability, and improves measurement accuracy. Cradling the gauge in your hand or holding it by the dial applies stress to the gauge plunger mechanism through the dial indicator housing.

---

## Zeroing the Gauge

1. Select the proper gauge for your connector. Always use gauges which are intended for pin depth measurements.
2. Inspect and clean the gauge:
  - a. Inspect the connector gauge and gauge master carefully, exactly as you inspected the connector itself.
  - b. Clean or replace the gauge and gauge master if necessary. Dirt on either the gauge or the gauge master makes gauge measurements inaccurate, and can damage a connector.

---

### NOTE

Check gauges often to make sure that the zero setting has not changed. Generally, when the pointer on a recently zeroed gauge does not line up with the zero mark exactly, the gauge or gauge master needs cleaning. Clean both of these carefully and check the zero setting again.

---



3. Zero the connector gauge:
  - a. While holding the gauge by the barrel, use the connecting knurl to screw on the gauge master just until you feel resistance.
  - b. Use the appropriate torque wrench to tighten the connecting nut of the gauge master.
  - c. As you watch the gauge pointer, gently tap the barrel of the gauge to settle the reading. The gauge pointer should line up exactly with the zero mark on the gauge. If not, clean and inspect both the gauge and gauge master. If the gauge and gauge master are clean and free from defects, adjust the zero set knob until the gauge pointer lines up exactly with zero.

## Gauging Techniques

These are generic instructions for screw-on type gauges. For specific instructions for using a 7 mm, 3.5 mm, or type-N gauge, see [“Connecting 7 mm Gauges” on page 3-24](#), and [“Connecting Type-N and 3.5 mm Gauges” on page 3-27](#).

---

### NOTE

While performing pin depth measurements, use different orientations of the gauge within the connector. Average a minimum of three readings, each taken after a quarter-turn rotation of the gauge, to reduce measurement variations that result from the gauge or the connector face not being exactly perpendicular to the center axis.

---

To zero a gauge, review the instructions in [“Zeroing Connector Gauges” on page 3-20](#).

### Using Male (Screw-on) Type Gauges

1. Attach the connector of the calibration module to be measured while holding the gauge by the barrel. Tighten the nut finger-tight without turning the gauge or calibration module.
2. Torque the connector to the appropriate torque value for the connector supplied (see [“Torque Wrench Information” on page 2-16](#)).
3. Gently tap the barrel of the gauge with your finger to settle the reading.
4. Measure the connector a minimum of three times, then average the readings for maximum accuracy.

### Using Female (Screw-on) Type Gauges

Screw on the connector of the calibration module to be measured while holding the gauge by the barrel. Connect the nut finger-tight without turning the gauge or calibration module.

5. Torque the connector using the appropriate value of torque for the connector supplied (see [“Torque Wrench Information” on page 2-16](#)).
6. Gently tap the barrel of the gauge with your finger to settle the reading.
7. Measure the connector a minimum of three times, then average the readings for maximum accuracy.

Compare your averaged reading with the “Observed Pin Depth Limits” in [Table 2-3](#) through [Table 2-6](#).

## Reading the Gauge

Gauge increment refers to the distance of one minor division between two adjacent minor divisions, or one-tenth of a major division (0.0001 inch). A gauge increment is the smallest value shown on the gauge face.

For each revolution of the large dial, the smaller dial indicates a change of 0.01 inch. Use the small dial as the indicator of multiples of 0.01 inch up to 0.25 inch. In most measuring applications, this value remains zero.

If the needle has moved clockwise, the center conductor is protruding and the value is determined by the *black* numbers.

If the needle has moved counterclockwise, the center conductor is recessed by an amount determined by the *red* numbers.

## 7 mm Gauge

---

**CAUTION**

You must remove the collet with the collet extractor tool prior to performing pin depth measurements.

---

**Figure 3-6** Using a 7 mm Connector Gauge

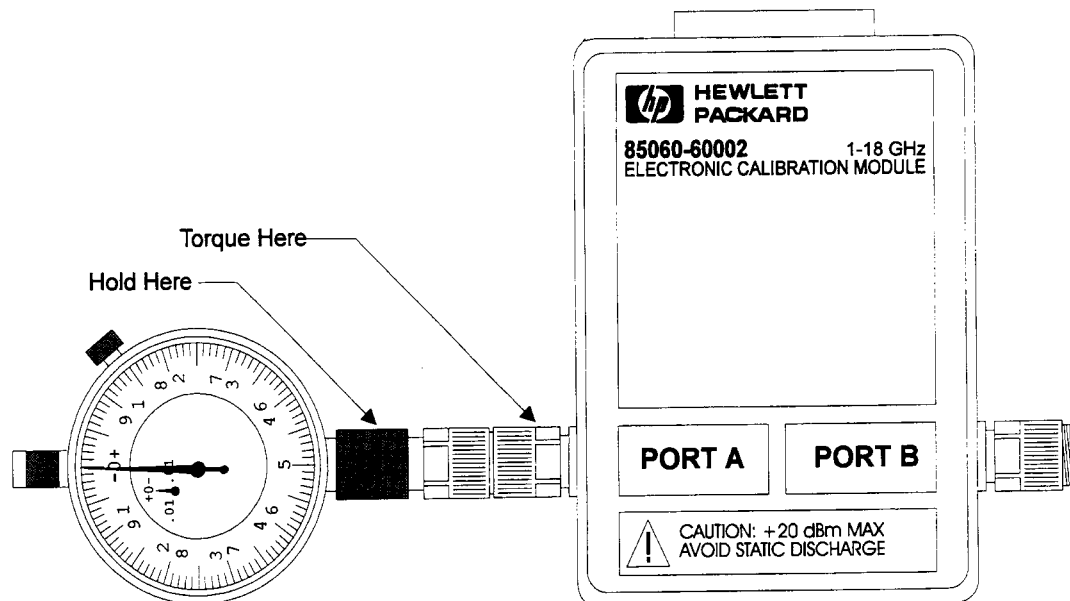

While performing pin depth measurements, use different orientations of the gauge with the connector. Average a minimum of three readings, each taken after a quarter-turn rotation of the gauge, to reduce measurement variations that result from the gauge or the connector face not being exactly perpendicular to the center axis.

To zero a gauge, review the instructions in [“Zeroing Connector Gauges” on page 3-20](#).

### Connecting 7 mm Gauges

Fully extend the connector sleeve on one of the connectors and fully retract the sleeve on the other. The extended sleeve creates a cylinder into which the second connector fits.

If one of the connectors is fixed (as on a test port), fully extend that connector sleeve (spin its knurled connector nut to make sure the threads are fully extended). Fully retract the connector sleeve on the other connector.

1. Remove the 7 mm collet from the center conductor with the collet extractor tool.
2. Carefully align the connectors.
3. As you bring one connector up to the other, and as you make the actual connection, be sure the connectors align perfectly.
4. Push the connectors straight together. Do not twist or screw them together.
5. Engage the connector nut over the threads on the second connector. Turn only the connector nut. Let the connector nut pull the two connectors straight together.

---

NOTE

At this point, you want a connection in which the outer conductors make gentle contact at all points on both mating surfaces. This requires very light finger pressure.

---

6. Relieve any side pressure on the connection from long or heavy devices or cables. This assures consistent torque while making the final connection.
7. Hold the torque wrench with your thumb and index finger behind the groove in the handle.
8. Tighten the connection until the handle begins to break at the torque setting (see technique in [Figure 3-5 on page 3-19](#)). It is not necessary to fully break the handle of the torque wrench to reach the specified torque.

Reverse the order of the steps above to disconnect the device.

### Type-N Gauge

See [“Connecting Type-N and 3.5 mm Gauges” on page 3-27](#) for more information.

**Figure 3-7 Using a Type-N Connector Gauge**

Use a screw-on female connector gauge.

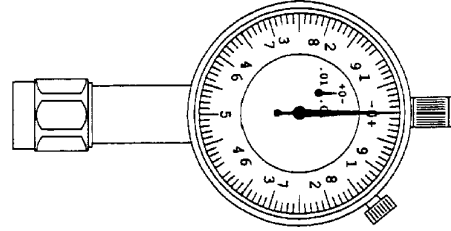

Connect gauge master and adjust gauge to correction value called out on gauge master label. Tighten dial lock screw after adjustment.

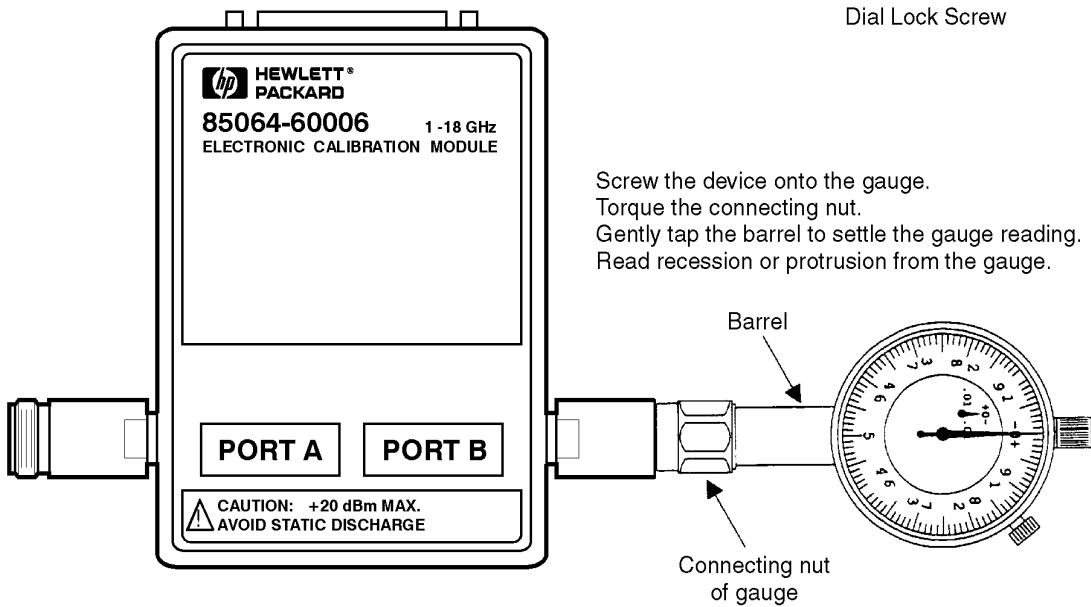
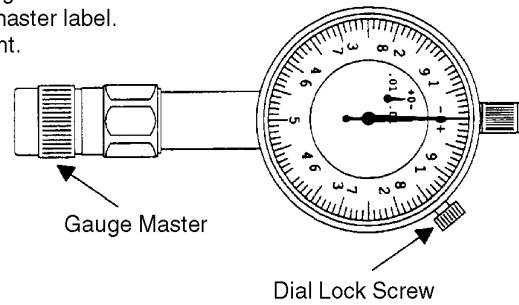

femlconn

### 3.5 mm Gauge

See "Connecting Type-N and 3.5 mm Gauges" on page 3-27 for more information.

**Figure 3-8** Using a 3.5 mm Connector Gauge

- Use screw-on female connector gauge

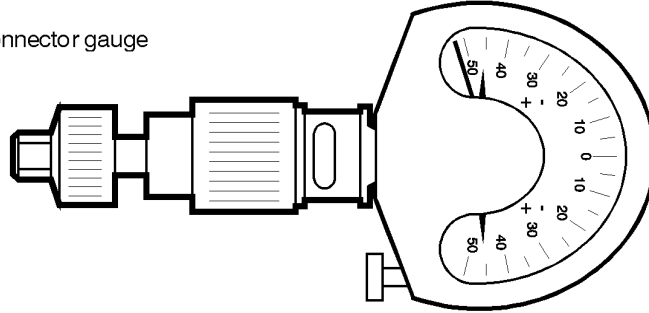

- Zero gauge using calibration block

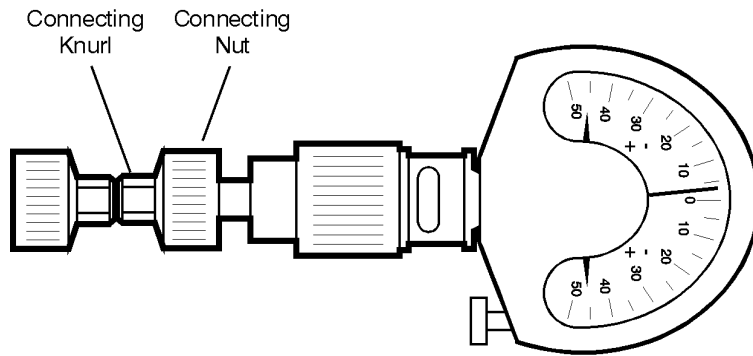

- Screw the device onto the gauge. Torque the connecting nut. Tap the device to settle the gauge. Read recession or protrusion from the gauge.

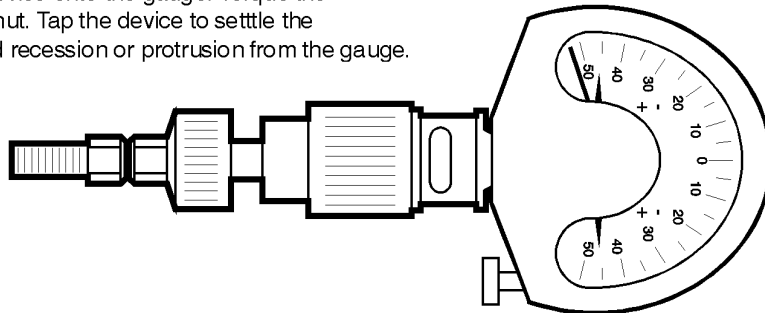

gageconn

## Connecting Type-N and 3.5 mm Gauges

When making connections to the calibration modules, turn the coupling nut on the male connector, *never turn the module itself*. Avoid rotating connectors relative to each other during the connect/disconnect process as this is the main source of connector wear.

1. Hand tighten the connection to be torqued.
2. Hold the torque wrench with your thumb and index finger behind the groove in the handle.
3. Tighten the connection until the handle begins to break loose. It is not necessary to fully break the handle of the torque wrench to reach the specified torque (see [Figure 3-5 on page 3-19](#)).
4. Reverse the order to disconnect.

---

### NOTE

When making connections to ECal modules with 3.5 mm devices, hold one device stationary while torquing the nut on the other device or cable connector. Use the open-ended wrench (HP part number 8710-1770) or the spanner wrench (HP part number 08513-20014). The torque supplied by the torque wrench can change with use. Recalibrate it at a schedule appropriate to its amount of use.

---

## Type-F Compatibility

### Male connectors

The precision type-F interface is compatible with the entire range of type-F connectors as defined by the Society of Cable Television Engineer's (SCTE) Interface Practices Sub Committee. Other type-F connector standards, such as those used by the International Electrotechnical Commission (IEC), may have different dimensional tolerances. Check to see that your connectors are compliant with the SCTE specifications before mating with the components in this kit. Particularly, check to see that the center conductor falls within a range of 0.56 to 1.07 mm (0.022 to 0.042 inches). For more information, refer to SCTE document IPS-SP-401.

The male pin gauge (HP part number 85099-60005) attached to the female connector on the module can be used to determine the diameter of the male pin. The gauge can also be used to verify the chamfer on the tip of the male pin.

### **Female connectors**

The precision type-F interface is defined by HP type-F Connector Interface A-1250-9059-1 rev. C. The inside diameter (ID) will ensure the specified performance with 0.77 to 0.86 mm (0.030 to 0.034 in) diameter male conductor. In addition, the ID will accept up to a 1.07 mm (0.042 in) diameter male conductor without compromising subsequent electrical performance with the 0.77 to 0.86 mm (0.030 to 0.034 in) diameter male conductor or degrade the electrical contact with the 0.56 mm (0.022 in) diameter male conductor.

---

**CAUTION**

Many type-F “feedthrough” connectors use the cable center conductor as the male pin. These cable center conductors often exceed the 1.07 mm (0.042 in) maximum pin specification and will destroy the calibration kit female standards. Damage will also occur to the female standards if the pins of the “feedthrough” connectors are not properly chamfered.

---



---

## Making Type-F Connections

Good connections require a skilled operator. *The most common cause of measurement error is poor connections.*

Typically all precision microwave connectors are designed with an alignment feature which engages prior to finger insertion to ensure alignment and support and avoid female finger damage.

The existing SCTE Interface Practices Subcommittee recommended “F” plug and part does not have any preinsertion alignment features. (See SCTE IPS-SP-4 and IPS-SP-401.) To avoid female finger failure, the burden of pin insertion alignment must be sustained by the user. Refer to [Figure 3-9](#).

### How to Make a Connection

1. Ground yourself and all devices. Wear a grounded wrist strap and work on an antistatic mat.
2. Visually inspect the connectors.
3. If necessary, clean the connectors.
4. Carefully align the connectors. The male connector center pin must slip concentrically into the contact fingers of the female connector.
5. Push the connectors straight together. Do *not* twist or screw them together. As the center conductors mate, there is usually a slight resistance.

---

**CAUTION**

Do *not* turn the device body. Only turn the connector nut. Major damage to the center conductor can occur if the device body is twisted.

---

6. The preliminary connection is tight enough when the mating plane surfaces make uniform, light contact. Do not overtighten this connection.

At this point all you want is a connection in which the outer conductors make gentle contact at all points on both mating surfaces. Very light finger pressure is enough.

7. Relieve any side pressure on the connection from long or heavy devices or cables.
8. Tighten the connector finger-tight. A torque wrench is not included with the type-F kit. If a torque wrench is needed, use one with a wrench opening of 12 mm and a torque setting of 170 N-cm.

**Figure 3-9**      **Type-F Female Connectors**

KEY CONSIDERATIONS TO AVOID FEMALE FINGER DAMAGE OR PREMATURE FAILURE

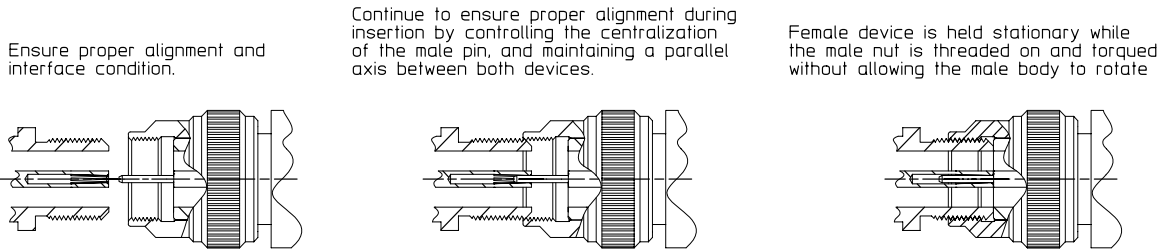

POTENTIAL CONDITIONS WHICH CAUSE FEMALE FINGER DAMAGE OR FAILURE

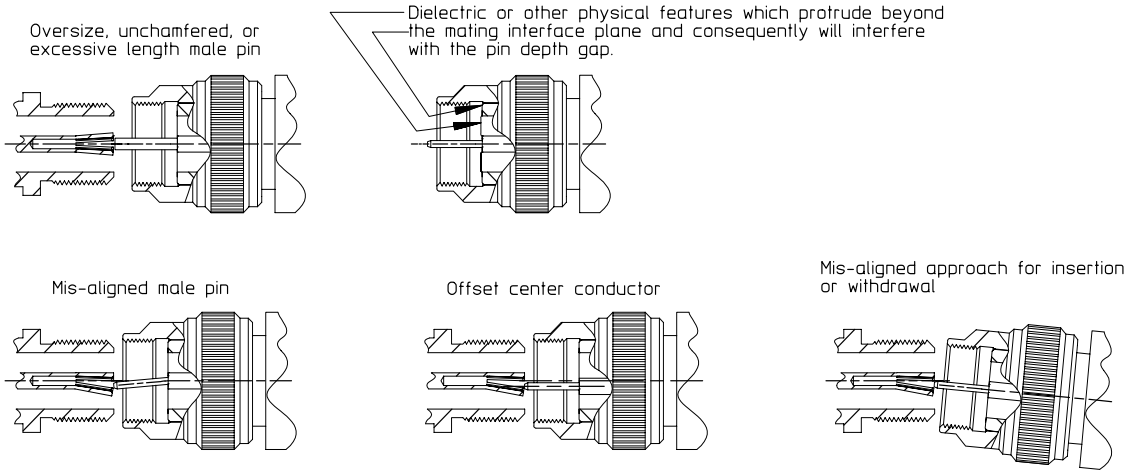

pk46b

## How to Separate a Connection

To avoid lateral (bending) force on the connector mating plane surfaces, always support the devices and connections.

1. Use an open-end wrench to prevent the device body from turning.
2. Use another open-end wrench to loosen the connector nut.
3. Complete the separation by hand, turning only the connector nut.

---

**CAUTION**

---

Turn the connector nut, *not* the device body. Major damage to the center conductor can occur if the device body is twisted.

4. Pull the connectors straight apart without twisting or bending.

---

## **4** **Replaceable Parts**

The following tables list the replacement part numbers for the ECal modules, options and accessories. [Table 4-5 on page 4-10](#) lists other items that may be ordered if necessary. To order a listed part, note the description, Hewlett-Packard part number, and the quantity desired. Telephone or send your order to the Hewlett-Packard office nearest you (sales and service offices are listed in [“Service and Support” on page 1-9](#) of this manual).

**Table 4-1      Parts for 3.5 mm ECal Modules**

Description	Qty	HP Part Number
<b>HP 85062B 1 GHz to 26.5 GHz Microwave ECal Modules</b>		
Module with Male/Female Connectors (Standard)	1	85062-60002
Module with Male/Male Connectors (Option 00M)	1	85062-60004
Module with Female/Female Connectors (Option 00F)	1	85062-60006
<b>HP 85093A 30 kHz to 6 GHz RF Ecal Modules</b>		
Module with Male/Female Connectors (85062B Option 001 or 85093A)	1	85093-60001
Module with Male/Male Connectors (85062B Option 001 and 00M, or 85093A Option 00M)	1	85093-60002
Module with Female/Female Connectors (85062B Option 01F, or 85093A Option 00F)	1	85093-60003
<b>Adapters (added with Option 00A)</b>		
3.5 mm Female/Female	1	85052-60012
3.5 mm Male/Male	1	85052-60014
<b>Protective End Caps</b>		
DB-25 Multi-pin Connector Cap	1	1252-4690
3.5 mm Female Connector Cap (for 3.5 mm adapter)	1	1401-0245
3.5 mm Male Connector Cap	1	1401-0246
3.5mm Male Connector Cap (for module connectors)	1	1401-0248
<b>Other</b>		
20 mm 90 N-cm (8 in-lb) Torque Wrench (Standard)	1	8710-1764
5/16 in 90 N-cm (8 in-lb) Torque Wrench (added with Option 00A)	1	8710-1765
Specification/Verification Program Disk (only with HP 85062B)	1	08510-10033
Electronic Calibration Module Reference Guide	1	85091-90008
Connector Care Quick Reference Card	1	08510-90360
<b>Items Not Included In Kits</b>		
3.5 mm Screw-on Pin Depth Gauge Set (male and female)		11752D
Spanner Wrench		08513-20014
3.5 mm Repair Kit with 10 Contacts		85052-60049
3.5 mm Slotless Contacts (pkg. of 10)		85052-60050
3.5 mm Slotless Contact (1 only)		85052-60051

Figure 4-1

HP 85093A and HP 85062B Modules and Accessories

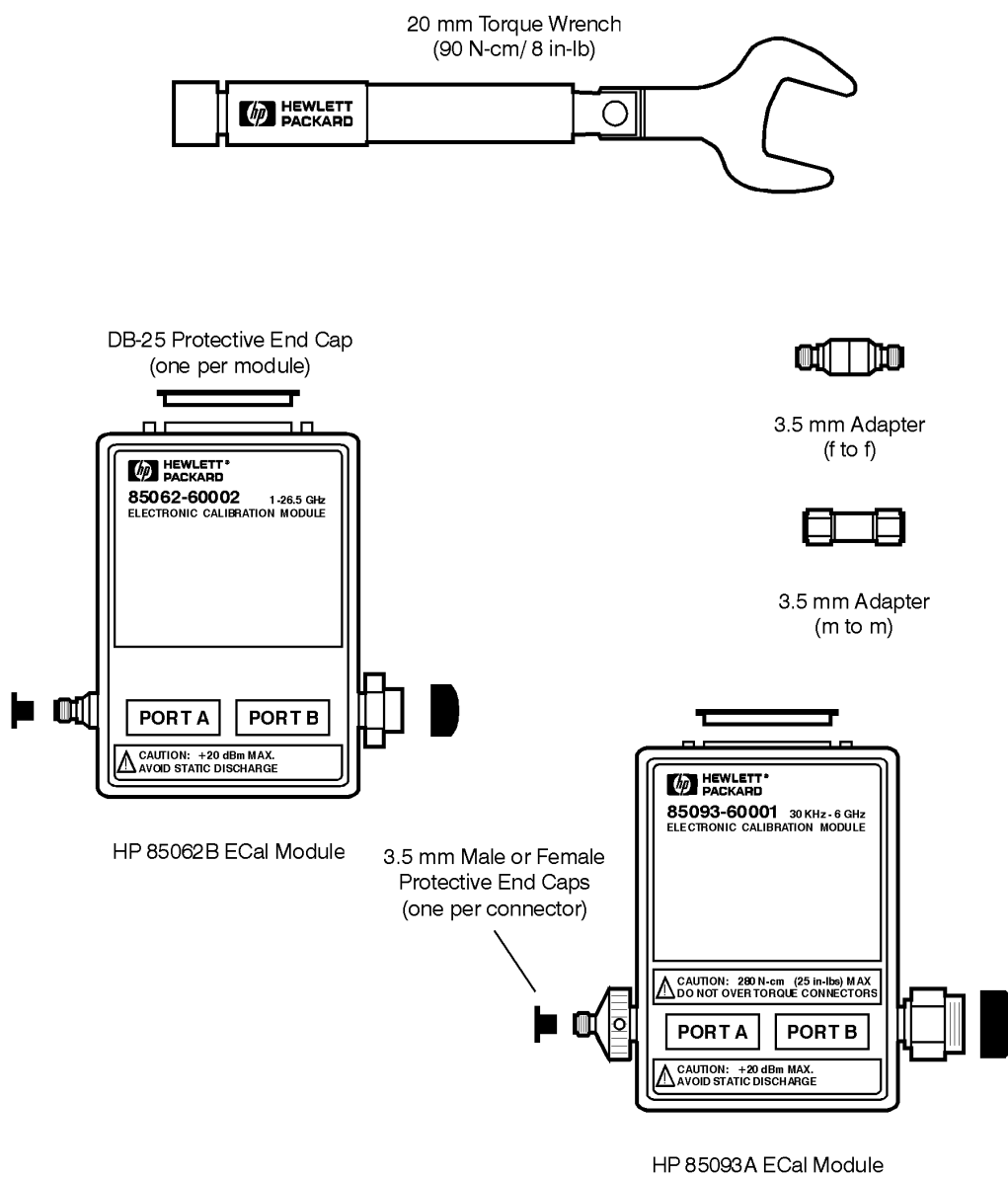

93rp001

**Not Shown:**

Module Reference Guide, Storage Case, Specification/Verification Program Disk, Option 00F (female-to-female), and Option 00M (male-to-male).

**Adapters:**

Adapters shown are available with Option 00A.

**Table 4-2**      **Parts for Type-N 50  $\Omega$  ECal Modules**

Description	Qty	HP Part Number
<b>HP 85064B 1 GHz to 18 GHz Microwave ECal Modules</b>		
Module with Male/Female Connectors (Standard)	1	85064-60002
Module with Male/Male Connectors (Option 00M)	1	85064-60004
Module with Female/Female Connectors (Option 00F)	1	85064-60006
<b>HP 85092A 30 kHz to 6 GHz RF ECal Modules</b>		
Insertable (85064B Option 001 or 85092A)	1	85092-60001
Module with Male/Male Connectors (85064B Option 001 and Option 00M or 85092A Option 00M)	1	85092-60002
Module with Female/Female Connectors (85064B Option 01F or 85092A Option 00F)	1	85092-60003
<b>Adapters (added with Option 00A)</b>		
Type-N Female/Female	1	85054-60037
Type-N Male/Male	1	85054-60038
<b>Protective End Caps</b>		
DB-25 Multi-pin Connector Cap	1	1252-4690
Type-N Female Connector Cap	1	1401-0247
Type-N Male Connector Cap	1	1401-0248
<b>Other</b>		
3/4 in 135 N-cm (12 in-lb) Torque Wrench (Standard)	1	8710-1766
Specification/Verification Program Disk (only with HP 85064B)	1	08510-10033
Electronic Calibration Module Reference Manual	1	85091-90008
Connector Care Quick Reference Card	1	08510-90360
<b>Items Not Included in Kits</b>		
Screw-on Type-N Pin Depth Gauge		85054-60049
1/2 in - 9/16 in Open-ended Wrench		8710-1770
Type-N Slotless Contact Repair Kit		85054-60056
Type-N Slotless Contacts (pkg. of 10)		85054-60057
Type-N Slotless Contact (1 only)		85054-60058

**Figure 4-2 HP 85092A and HP 85064B Modules and Accessories**

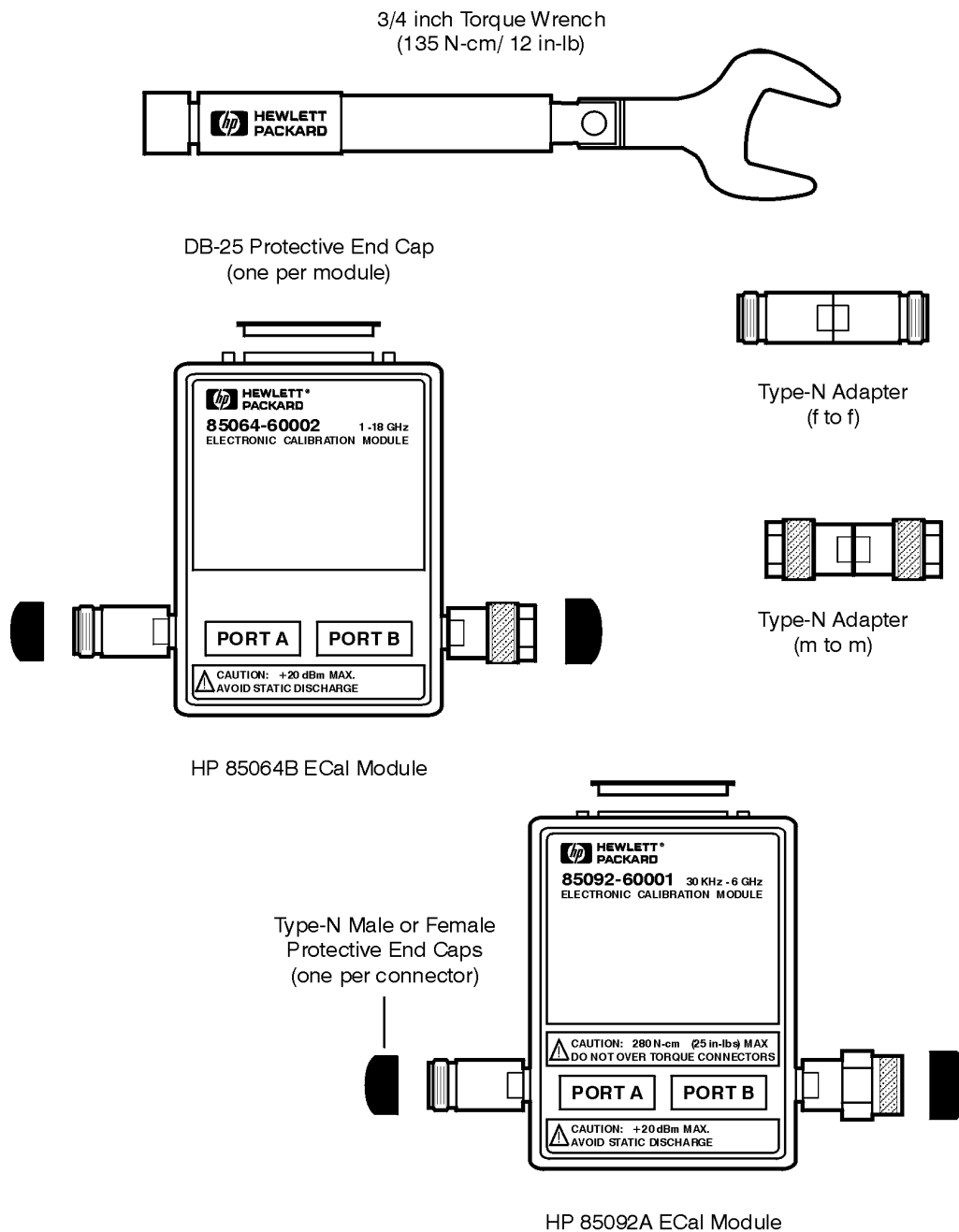

92rp001

**Not Shown:**

Module Reference Guide, Storage Case, Specification/Verification Program Disk, Option 00F (female-to-female), and Option 00M (male-to-male).

**Adapters:**

Adapters shown are available with Option 00A.



**Table 4-3**      **Parts for Type-N 75  $\Omega$  ECal Modules**

Description	Qty	HP Part Number
<b>HP 85096A 30 kHz to 3 GHz RF ECal Modules</b>		
Module with Male/Female Connectors (85096A)	1	85096-60001
Module with Male/Male Connectors (85096A Option 00M)	1	85096-60002
Module with Female/Female Connectors (85096A Option 00F)	1	85096-60003
<b>Adapters (added with Option 00A)</b>		
Type-N Female/Female	1	85036-60014
Type-N Male/Male	1	85036-60013
<b>Protective End Caps</b>		
DB-25 Multi-pin Connector Cap	1	1252-4690
Type-N Female Connector Cap	1	1401-0247
Type-N Male Connector Cap	1	1401-0248
<b>Other</b>		
Electronic Calibration Module Reference Guide	1	85091-90008
Connector Care Quick Reference Card	1	08510-90360
<b>Items Not Included in Kits</b>		
Screw-on Type-N 75 $\Omega$ Pin Depth Gauge	85036B Opt K01	
1/2 in - 9/16 in Open-ended Wrench	8710-1770	
3/4 in 135 N-cm (12 in-lb) Torque Wrench	8710-1766	

**Figure 4-3 HP 85096A Module and Accessories**

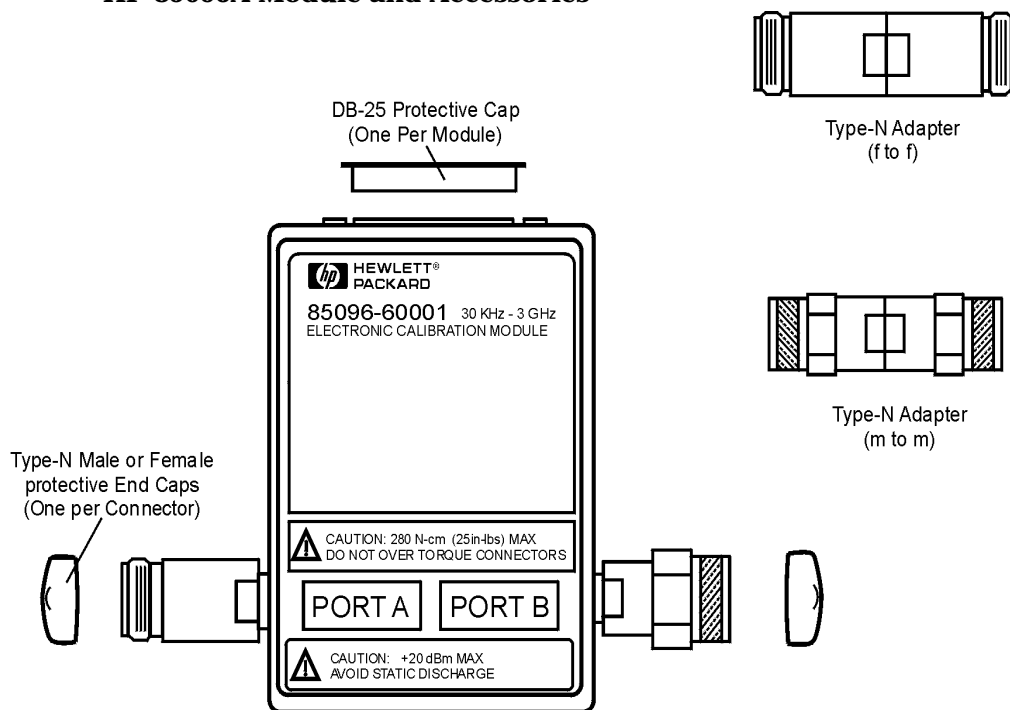

kl32a

**Not Shown:**

Module Reference Guide, Storage Case, Specification/Verification Program Disk, Option 00F (female-to-female), and Option 00M (male-to-male).

**Adapters:**

Adapters shown are available with Option 00A.

**Table 4-4**                    **Parts for 7-16 ECal Modules**

Description	Qty	HP Part Number
<b>HP 85098A 30 kHz to 7.5 GHz RF ECal Modules</b>		
Module with Male/Female Connectors (85098A)	1	85098-60001
Module with Male/Male Connectors (85098A Option 00M)	1	85098-60002
Module with Female/Female Connectors (85098A Option 00F)	1	85098-60003
<b>Adapters</b> (added with Option 00A)		
7-16 Female/Female	1	11906-80016
7-16 Male/Male	1	11906-80015
<b>Protective End Caps</b>		
DB-25 Multi-pin Connector Cap	1	1252-4690
7-16 Male Connector Cap	1	1401-0417
7-16 Female Connector Cap	1	1401-0418
<b>Other</b>		
1-1/16 in 226 N-cm (20 in-lb) Torque Wrench (Standard)	1	8710-2175
Electronic Calibration Module Reference Manual	1	85091-90008
Connector Care Quick Reference Card	1	08510-90360
15/16 in Open-ended Wrench	1	8710-2174

**Figure 4-4 HP 85098A Module and Accessories**

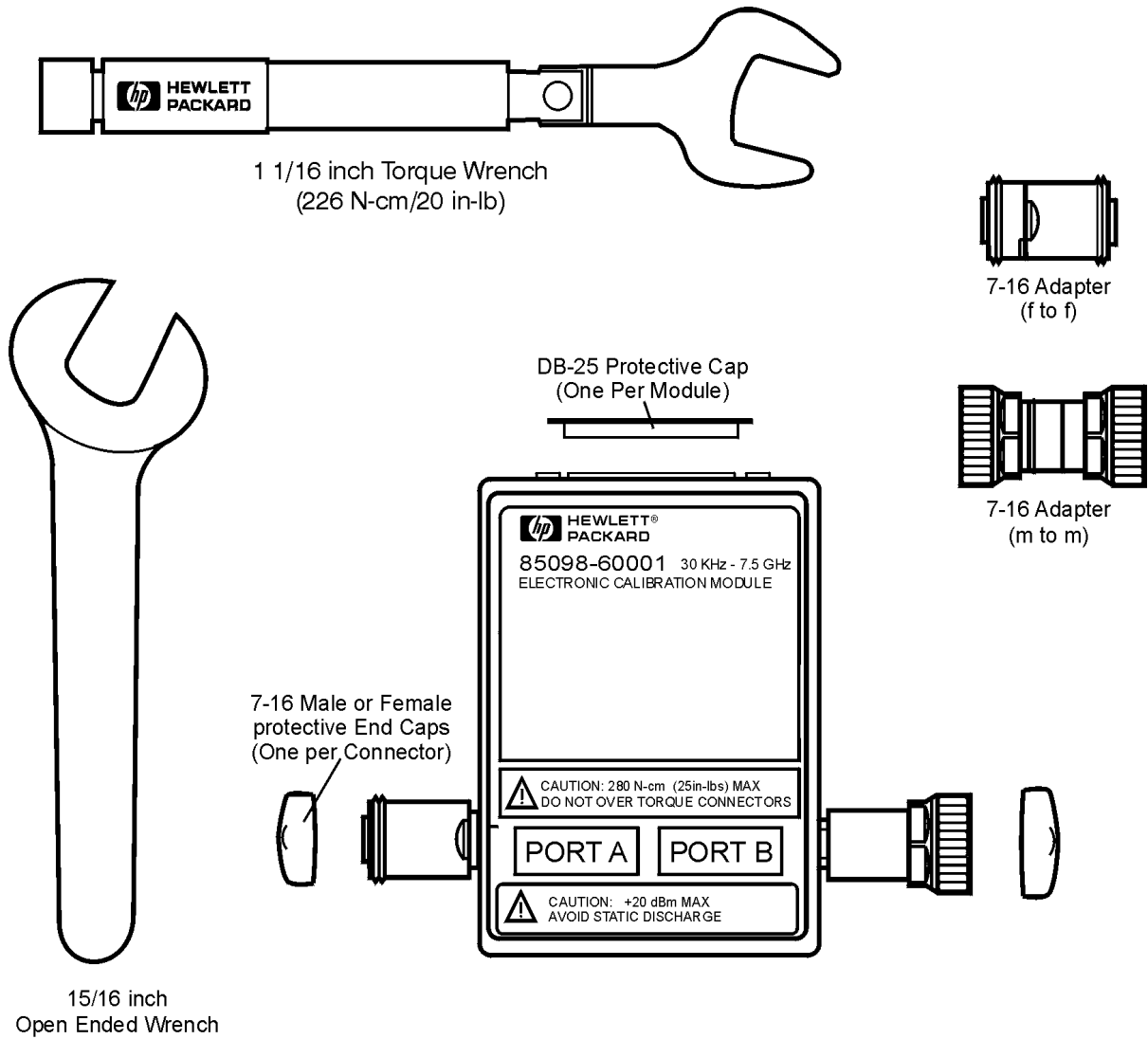

kl33a

**Not Shown:**

Module Reference Guide, Storage Case, Specification/Verification Program Disk, Option 00F (female-to-female), and Option 00M (male-to-male).

**Adapters:**

Adapters shown are available with Option 00A.

**Table 4-5**      **Parts for Type-F ECal Modules**

Description	Qty	HP Part Number
<b>HP 85099A 30 kHz to 3 GHz RF ECal Modules</b>		
Module with Male/Female Connectors (85099A)	1	85099-60001
Module with Male/Male Connectors (85099A Option 00M)	1	85099-60002
Module with Female/Female Connectors (85099A Option 00F)	1	85099-60003
<b>Adapters</b> (added with Option 00A)		
Type-F Female/Female	1	85039-60002
Type-F Male/Male	1	85039-60006
<b>Protective End Caps</b>		
DB-25 Multi-pin Connector Cap	1	1252-4690
Type-F Female Connector Cap	1	1401-0296
Type-F Male Connector Cap	1	1401-0297
<b>Other</b>		
12 mm Open-ended Wrench	1	8710-1841
Electronic Calibration Module Reference Manual	1	85091-90008
Connector Care Quick Reference Card	1	08510-90360
Pin Gauge (attached to module: see <a href="#">Figure 4-5</a> )	1	85099-60005
<b>Items Not Included in Kits</b>		
1/2 in - 9/16 in Open-ended Wrench	1	8710-1770

**Figure 4-5 HP 85099A Module and Accessories**

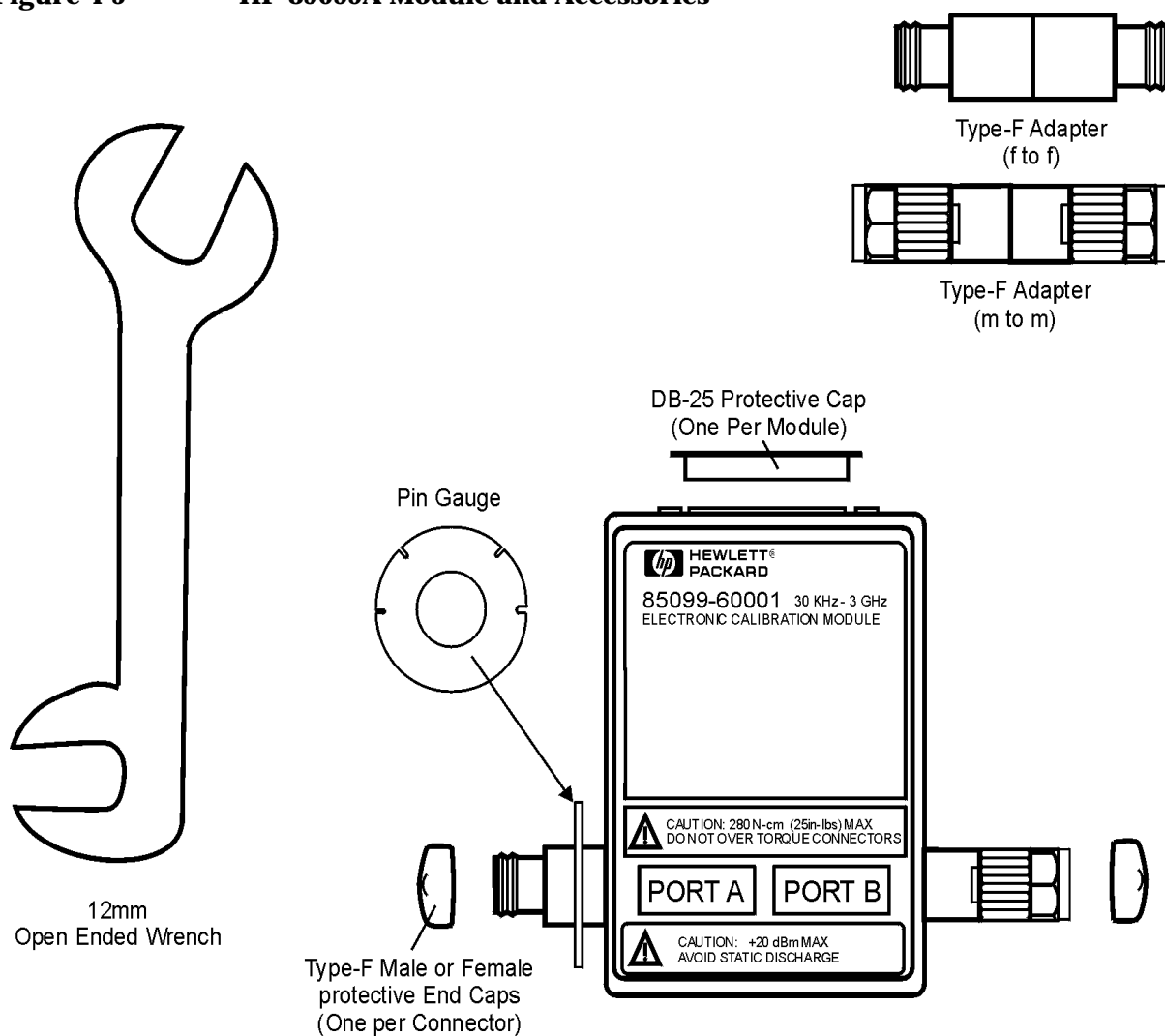

kl34a

**Not Shown:**

Module Reference Guide, Storage Case, Specification/Verification Program Disk, Option 00F (female-to-female), and Option 00M (male-to-male).

**Adapters:**

Adapters shown are available with Option 00A.

**Table 4-6**            **Parts for 7 mm ECal Modules**

Description	Qty	HP Part Number
<b>HP 85060B 1 GHz to 18 GHz Microwave ECal Module</b>	1	85060-60002
<b>HP 85091A 30 kHz to 6 GHz RF ECal Module (85060B Option 001)</b>	1	85091-60001
<b>Protective End Caps</b>		
DB-25 Multi-pin Connector Cap	1	1252-4690
7 mm Connector Cap	1	1401-0249
<b>Other</b>		
3/4 mm 135 N-cm (12 in-lb) Torque Wrench (Standard)	1	8710-1766
7 mm Collet Extractor Tool	1	5060-0370
Specification/Verification Program Disk (only with HP 85060B)	1	08510-10033
Electronic Calibration Module Reference Manual	1	85091-90008
Connector Care Quick Reference Card	1	08510-90360
<b>Items Not Included in 7 mm ECal Kits</b>		
Screw-on 7 mm Pin Depth Gauge	1	85050-80012
7 mm Repair Kit (includes collet extractor tool)	1	11591A
1/2 in to 9/16 in Open-end Wrench	1	8710-1770

**Figure 4-6**

**HP 85091A and HP 85060B Modules and Accessories**

3/4 inch Torque Wrench  
(135 N-cm/ 12 in-lb)

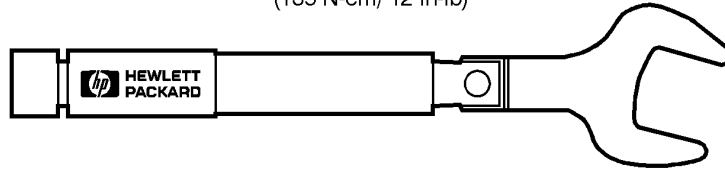

DB-25 Protective End Cap  
(one per module)

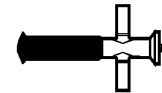
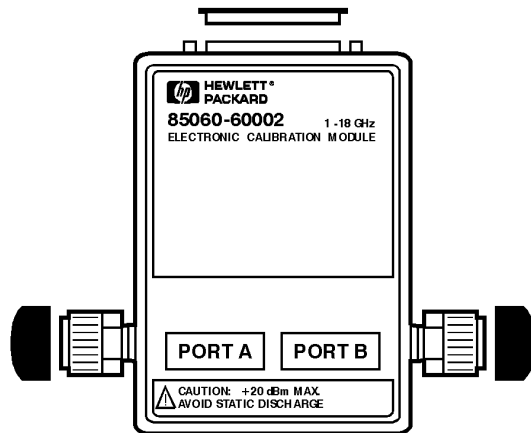

7 mm Connector  
Collet  
Extractor Tool

HP 85060B ECal Module

7 mm  
Protective End Caps  
(one per connector)

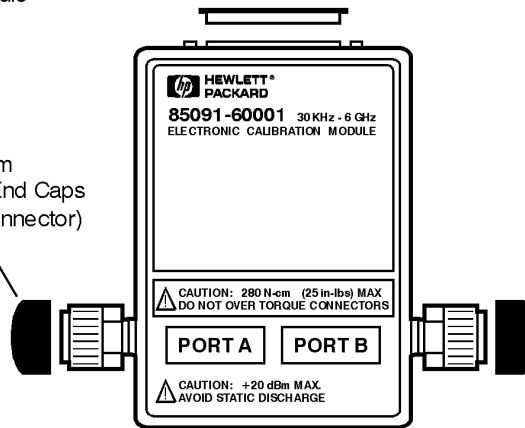

HP 85091A ECal Module

91rp001

**Not Shown:**

Module Reference Guide, Storage Case, Specification/Verification Program Disk, Option 00F (female-to-female), and Option 00M (male-to-male).



**Table 4-7**                      **Miscellaneous Other Supplies (not included)**

Description	Qty	HP Part Number
<b>Cleaning Supplies</b>		
Compressed Air	1 can (235 ml)	8500-6659
99.5% Isopropyl Alcohol (8 oz)	8 oz	8500-0559
99.5% Isopropyl Alcohol (30 ml)	30 ml	8500-5344
Cleaning Swabs	100	9301-1243
Lint-free Cleaning Cloth	150	9310-4242
<b>ESD Supplies</b>		
Grounding Wrist Strap	1	9300-1367
5 ft. Wrist-strap to Table-mat Grounding Cord	1	9300-0980
2 x 4 ft. Conductive Table Mat with 15 ft. Ground Wire	1	9300-0797
ESD Heel Strap	1	9300-1126

---

# Index

---

## A

accuracy enhancement, [2-4](#)

## B

barometric pressure, [2-4](#)

## C

characteristics  
  electrical, [2-14](#)  
compatibility of connectors, [3-27](#)  
compatible VNAs, [1-3](#)  
connections  
  final, [3-27](#)  
  initial, [3-18](#)  
connector  
  compatibility, [3-27](#)  
connector pin depth information  
  3.5 mm, [2-8](#)  
  7 mm, [2-8](#)  
  type-N, [2-8](#)  
connectors  
  cleaning, [3-8](#)  
    interior surfaces, [3-9](#)  
    mating plane, [3-9](#)  
    precision 7 mm cleaning  
      procedure, [3-11](#)  
    threads, [3-9](#)  
    with compressed air, [3-9](#)  
    with nitrogen, [3-9](#)  
  required but not supplied, [1-4](#)  
  when to gauge, [3-12](#)  
  zeroing the gauge, [3-20](#)

## E

electrical characteristics, [2-14](#)  
electrical specifications, [2-10](#)  
  microwave, [2-14](#)  
electrostatic discharge, [3-3](#)  
environmental specifications, [2-3](#)

## F

final connection, [3-27](#)

## G

gage  
  female (screw-on type), [3-22](#)  
gauge  
  3.5 mm connector  
    female, [3-15](#)  
  7 mm connector, [3-16](#), [3-22](#)  
  accuracy, [3-12](#)  
  connector, [3-14](#)  
  gauging techniques, [3-22](#)  
  intent, [3-12](#)  
  type-N

  female, [3-24](#)  
  type-N connector, [3-17](#)  
  types, [3-14](#)  
gauging, [3-1](#)  
  electrostatic discharge, [3-3](#)  
  handling and storage, [3-2](#)  
  techniques, [3-22](#)  
  when, [3-12](#)  
gauging devices, [3-12](#)  
general information, [1-1](#)

## I

initial connection, [3-18](#)  
inspection, [1-4](#)

## M

making connections, [3-1](#)  
  electrostatic discharge, [3-3](#)  
  handling and storage, [3-2](#)  
mechanical characteristics  
  center conductor protrusion, [2-5](#)  
  pin depth, [2-5](#)

## O

operating temperature, [2-4](#)

## R

relative humidity, [2-4](#)  
replaceable parts  
  3.5 mm, [4-2](#)  
  7 mm  
    option 001, [4-13](#)  
  7-16, [4-9](#)  
  type-N  
    option 001, [4-5](#)  
    option 001 and option 00F,  
      [4-5](#), [4-7](#)  
RF kit contents  
  available options, [1-5](#), [2-14](#)

## S

serial numbers, [1-7](#)  
shipping instructions, [1-8](#)  
specifications  
  electrical, [2-10](#)  
  microwave, [2-14](#)  
  environmental, [2-3](#)  
specifications and characteristics  
  accuracy-enhanced temperature  
    range, [2-2](#)  
  connector pin depth values, [2-2](#)  
  definitions, [2-2](#)  
  measurement calibration, [2-2](#)  
  operating temperature range,  
    [2-2](#)

  references to connector sex, [2-2](#)

## T

type-F compatibility, [3-27](#)

## W

warranty, [2-17](#)

## Z

zeroing the connector gauge, [3-20](#)